

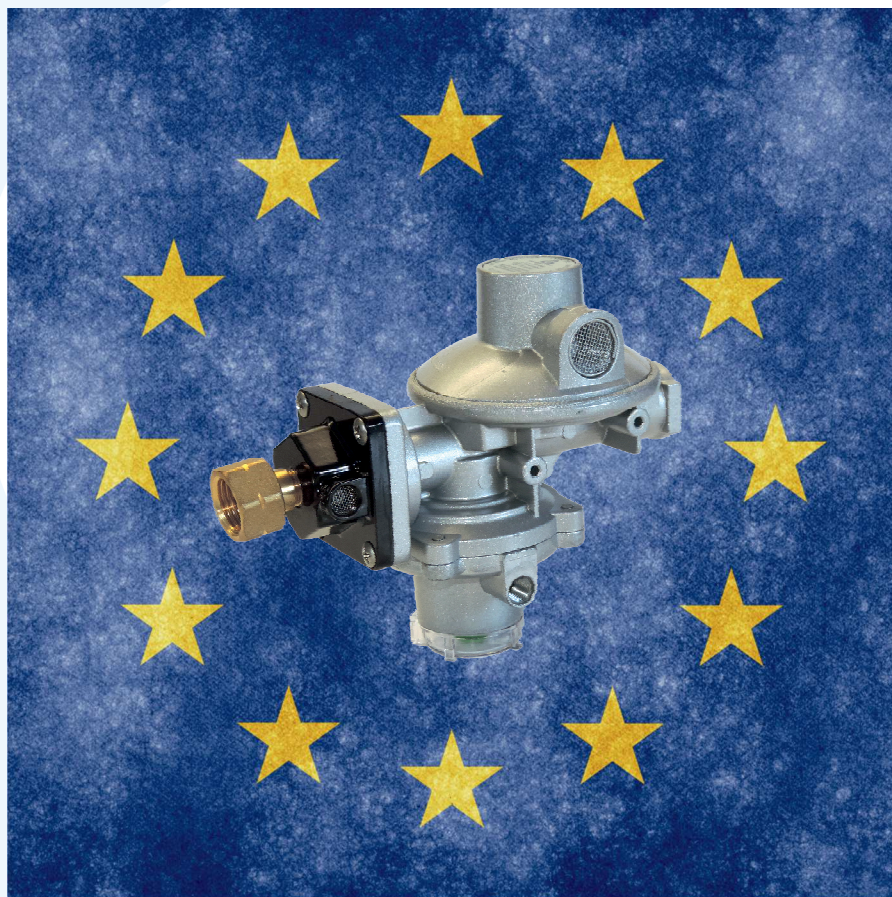

Cavagna group

Wherever gas is used, we are there



Regulators & Accessories for European Tank installations



Solutions

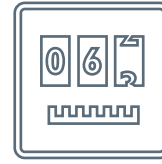
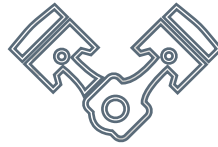

LPG SOLUTIONS

COMPRESSED GASES SOLUTIONS

NATURAL GAS SOLUTIONS

ALTERNATIVE FUEL SYSTEMS

GAS METERING SOLUTIONS

OTHER



Since 1949, the Cavagna Group has supplied the worldwide gas control industry with products of superior quality and value.
Our new comprehensive catalog features a complete line of products and accessories for the LPG and cryogenic gas containers.

Cavagna is a registered trademark.
© Copyright 2003 Cavagna North America, Inc.

The Cavagna Group began operation in 1949 in Northern Italy and continues to grow today. Since its origin, the Group has become a world leader in the forging and machining of brass and stainless steel. For over seventy years the Group has supplied safe products of superior quality and value. Technological advancement and sophisticated working procedures have allowed us to rapidly create new products and solutions for the gas control industry. The Cavagna Group produces a wide range of products meeting international standards including:

- LPG Valves and Regulators
- Natural Gas regulators for domestic and industrial use
- ASME, Fork Lift, and Motor Fuel Tank Valves
- High Pressure Cylinder Valves
- Refrigeration Cylinder Valves
- Distribution and Regulation Equipment for Industrial Gases
- Distribution and Regulation Equipment for Medical Gases
- Comprehensive Range of Welding, Cutting Equipment and Special Gases
- CNG - AUTOGAS products

The Group's design engineers and laboratory technicians closely cooperate with worldwide regulatory institutions, both in the writing of international performance standards and in the creation of new products. In North America our products are recognized by AGA, ASME, CGA, IAS, and UL as conforming to ANSI, NFPA and other recognized standards.

The Cavagna Group of companies has invested heavily in personnel, individual training, and robotic technology to meet the quality standards required by our customers and the 140 countries we serve. With the establishment of Cavagna North America in 1996 and our North American Distribution Center, we have further expanded our service network to meet the demands of the global marketplace.

Our philosophy is to provide all of our customers with quality products, continuous innovation and superior service in a competitive environment.



| | |
|---|-------------|
| 1.EN 16129 regulatory requirements | P.5 |
| 2.Tank regulators & accessories - Residential/Commercial | P.17 |
| 3.Tank regulators - Industrial | P.45 |
| 4.Tank installations national guidelines (examples) | P.55 |



cavagna group

Wherever gas is used, we are there

1. EN 16129 regulatory requirements

| | | |
|-------------|-------------------------------------|-------------|
| 1.A. | Regulators | P.6 |
| 1.B. | Safety devices | P.9 |
| 1.C. | Annex G - Inlet connections | P.13 |
| 1.D. | Annex H - Outlet connections | P.14 |

Regulators

The regulators are classified according to their use and according to the particular system they regulate the gas with. Therefore, first stage regulators and second stage regulators are designed to be used for residential and commercial installations. The first stage regulator is a regulator reducing the inlet pressure, coming from the withdrawal cylinder or tank, to a medium level suitable to feed consequently a second stage regulator, thus the first stage regulator reduces pressure as per EN16129. The second stage regulator is a regulator reducing the pressure, coming from a first stage regulator, directly to the inlet pressure of the user's appliances or to a medium pressure value in case of installations with Pressure Line Regulators or a three stage installation.

Cavagna Group gas regulators for residential and commercial installations are complying with EN. They are designed to be installed outdoors, following the manufacturer's instructions of installation.

Cavagna Group Pressure Line Regulators are used in natural gas or in LPG installations, following a second stage regulator with medium pressure value. Pressure Line Regulators are regulators that are located upstream user's appliances to compensate possible pressure drops coming from the supply system or distribution network. All Pressure Line Regulators are designed for indoor installations and are complying with EN relevant standard.

Materials used for construction of products in this catalog are suitable for rated service pressure at temperatures of -20°C to +50°C, unless otherwise specified.

i. § 6.2.1 Supply and regulated pressures for regulators to be used on installations where the final pressure is to EN 437

1. § 6.2.1.2 Two stage installation with fixed or adjustable regulators

The first stage regulator is connected to the tank valve. It supplies a second stage regulator that is usually installed nearby the house. Length and diameter of gas pipes connecting the first stage regulator to the second stage regulator have to be calculated in order to ensure the minimum supplying pressure to the regulator of second stage and to ensure the maximum allowed capacity to gas appliances.

At the same time length and diameter of gas pipes connecting the second stage regulator outlet to gas appliances have to be calculated in order to respect the maximum authorized capacity and pressure drop, as well as to ensure good functioning of the installation.

The first stage regulator must be mounted with cover turned upwards, but slightly bending downwards – please, refer to figure 1 – in order to allow the vent-hole to vent out possible water, which may enter the regulator.

The second stage regulator is usually installed outdoors and has to have its vent turned downwards, away from eventual openings of the building.

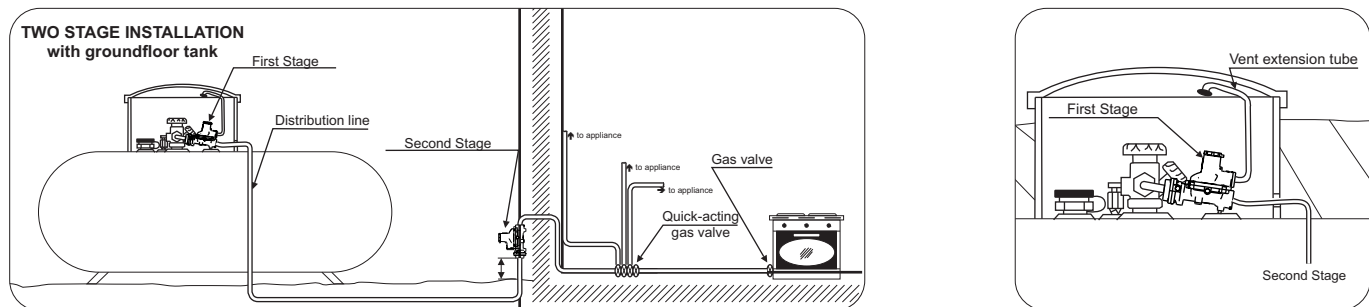

Figure 1

The **supply pressure of the first regulator** is defined at § 6.2.1.2.1 of EN16129.

Butane: minimum: 0,3 or $p_d + 0,2$ if greater - maximum: 7,5 bar

LPG: minimum: 0,3 or $p_d + 0,2$ if greater - maximum: 16 bar

Propane: minimum: 1 or $p_d + 0,5$ if greater - maximum: 16 bar

The **regulated pressure** must be in conformity with the following table:

| Definition of the pressure | Numerical values given for information <small>Table 6 of EN16129</small> | | | | | | | | | |
|--------------------------------------|--|------|------|------|------|------|------|------|------|--|
| Nominal regulated pressure (p_d) | | 3 | 1,5 | 1 | 0,75 | 0,5 | 0,4 | 0,3 | 0,15 | |
| Maximum lock up pressure (p_o) | = $p_d \times 1,3$ | 3,90 | 1,95 | 1,30 | 0,98 | 0,65 | 0,52 | 0,39 | 0,20 | |
| Maximum pressure (p_{Mp}) | = $p_d \times 1,2$ | 3,60 | 1,80 | 1,20 | 0,90 | 0,60 | 0,48 | 0,36 | 0,18 | |
| Minimum pressure (p_{Mg}) | = $p_d \times 0,7$ | 2,10 | 1,05 | 0,70 | 0,53 | 0,35 | 0,28 | 0,21 | 0,11 | |
| Minimum pressure after limiter | = $(p_d \times 0,7) - (p_d \times 0,3)$ | 1,2 | 0,6 | 0,4 | 0,3 | 0,2 | 0,16 | 0,12 | 0,06 | |

Regulators

The **supply pressure of the last regulator** is defined at § 6.2.1.2.2 of EN16129. Minimum and maximum supplied pressures shall be declared. The minimum declared pressure shall be equal or less than those given in Table 7. Then maximum declared pressure shall be equal or greater than those given in Table 7.

| Definition of the pressure | Table 7 of EN16129 | | | | | | | | |
|---|--|------|------|------|------|------|------|------|--|
| | Numerical values given for information | | | | | | | | |
| Nominal regulated pressure of the upstream regulator (p_d) | 3 | 1,5 | 1 | 0,75 | 0,5 | 0,4 | 0,3 | 0,15 | |
| Maximum pressure = $p_d \times 1,3$ | 3,90 | 1,95 | 1,30 | 0,98 | 0,65 | 0,52 | 0,39 | 0,20 | |
| Minimum pressure (with 15% pressure loss) = $p_d \times 0,7 \times 0,85$ | 1,79 | 0,89 | 0,60 | 0,45 | 0,30 | 0,24 | 0,18 | 0,09 | |
| Minimum pressure (with limiter and 15% pressure loss) = $((p_d \times 0,7) - (p_d \times 0,3)) \times 0,85$ | 1,02 | 0,51 | 0,34 | 0,26 | 0,17 | 0,14 | 0,10 | 0,05 | |

The **regulated pressure** must be in conformity with the following table:

| Gas | Regulator supply pressure bar | Regulator regulated pressure mbar | | | | Maximum downstream installation pressure loss mbar | Appliance supply pressure ^a mbar | | | Appliance categories ^a |
|---------|----------------------------------|--------------------------------------|----------|----------|-------|---|--|-----------|-----------|-----------------------------------|
| | | p_d | p_{Mg} | p_{Mp} | p_o | | p_n | p_{min} | p_{max} | |
| Butane | 0,3 to 7,5 | 29 | 22 | 35 | 40 | 2 | 29 | 20 | 35 | 3B and 3+ |
| Butane | 0,3 to 7,5 | 50 | 47,5 | 57,5 | 62,5 | 5 | 50 | 42,5 | 57,5 | 3+ |
| Butane | 0,3 to 7,5 | 112 | 65 | 140 | 145 | 5 | 112 | 60 | 140 | 3+ |
| LPG | 0,3 to 16 | 29 | 27 | 35 | 40 | 2 | 29 | 25 | 35 | 3B/P |
| LPG | 0,3 to 16 | 50 | 47,5 | 57,5 | 62,5 | 5 | 50 | 42,5 | 57,5 | 3B/P |
| Propane | 1 to 16 | 30 | 27 | 35 | 40 | 2 | 30 | 25 | 35 | 3P |
| Propane | 1 to 16 | 37 | 27 | 45 | 50 | 2 | 37 | 25 | 45 | 3P and 3+ |
| Propane | 1 to 16 | 37 | 30 | 45 | 50 | 5 | 37 | 25 | 45 | 3P and 3+ |
| Propane | 1 to 16 | 50 | 47,5 | 57,5 | 62,5 | 5 | 50 | 42,5 | 57,5 | 3P |
| Propane | 1 to 16 | 67 | 55 | 80 | 85 | 5 | 67 | 50 | 80 | 3+ |
| Propane | 1 to 16 | 148 | 105 | 180 | 185 | 5 | 148 | 100 | 180 | 3+ |

^a Data taken from EN 437.

2. § 6.2.1.3 Three stage installation with fixed or adjustable regulators

The installation with Three stage is similar to Two stage installations, however the supplying outlet pressure of the second stage regulator is a medium pressure.

The outlet pressure of the second stage regulator is stabilized by a Pressure Line Regulator placed inside the building, which supply gas appliances at normal pressure of the appliance.

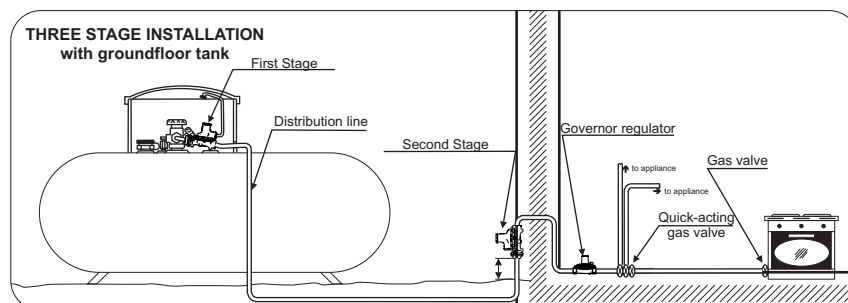

Regulators

The **supply pressure of the first regulator** is defined at § 6.2.1.3.1 of EN16129.

- Butane: minimum: 0,3 or $p_d + 0,2$ if greater - maximum: 7,5 bar
- LPG: minimum: 0,3 or $p_d + 0,2$ if greater - maximum: 16 bar
- Propane: minimum: 1 or $p_d + 0,5$ if greater - maximum: 16 bar

The **regulated pressure** must be in conformity with the table 6 of EN16129.

The **supply pressure of the intermediate regulator** is defined at § 6.2.1.3.2 of EN16129.

Minimum and maximum supplied pressures shall be declared.

The minimum declared pressure shall be equal or less than those given in Table 7.

Then maximum declared pressure shall be equal or greater than those given in Table 7.

The **regulated pressure** must be in conformity with the following table:

| Definition of the pressure | | Numerical values given for information | | | | | | | | | |
|--------------------------------------|--------------------|--|------|------|------|------|------|------|------|--------------------|--|
| Nominal regulated pressure (p_d) | | 3,00 | 1,5 | 1 | 0,75 | 0,5 | 0,4 | 0,3 | 0,15 | 0,075 ^a | |
| Maximum lock up pressure (p_0) | $= p_d \times 1,3$ | | 1,95 | 1,30 | 0,98 | 0,65 | 0,52 | 0,39 | 0,20 | 0,090 | |
| Maximum pressure (p_{Mp}) | $= p_d \times 1,2$ | | 1,80 | 1,20 | 0,90 | 0,60 | 0,48 | 0,36 | 0,18 | 0,086 | |
| Minimum pressure (p_{Mg}) | $= p_d \times 0,7$ | | 1,05 | 0,70 | 0,53 | 0,35 | 0,28 | 0,21 | 0,11 | 0,064 | |

Table 10 of EN16129

^a For this pressure value, the coefficient 1,3 is replaced by 1,2, the coefficient 1,2 is replaced by 1,15 and the coefficient 0,7 is replaced by 0,85.

The **supply pressure of the last regulator** is defined at § 6.2.1.3.1 of EN16129.

| Definition of the pressure | | Numerical values given for information | | | | | | | | | |
|--|--------------------------------|--|------|------|------|------|------|------|------|--------------------|--|
| Nominal regulated pressure of the upstream regulator (p_d) | | 3 | 1,5 | 1 | 0,75 | 0,5 | 0,4 | 0,3 | 0,15 | 0,075 ^a | |
| Maximum pressure | $= p_d \times 1,3$ | | 1,95 | 1,30 | 0,98 | 0,65 | 0,52 | 0,39 | 0,20 | 0,090 | |
| Minimum pressure (with 15% pressure loss) | $= p_d \times 0,7 \times 0,85$ | | 0,89 | 0,60 | 0,45 | 0,30 | 0,24 | 0,18 | 0,09 | 0,054 | |

Table 11 of EN16129

^a For this pressure value, the coefficient 1,3 is replaced by 1,2 and the coefficient 0,7 is replaced by 0,85.

The **regulated pressure** must be in conformity with the table 5 of EN16129.

ii. § 6.2.2 Supply and regulated pressures for fixed or adjustable regulators to be used on installations where the final pressure is not to EN 437

Supply pressure:

Regulators directly supplied at the gas container pressure:

- Butane: minimum: 0,3 or $p_d + 0,2$ if greater – maximum: 7,5 bar
- LPG: minimum: 0,3 or $p_d + 0,2$ if greater – maximum: 16 bar
- Propane: minimum: 1 or $p_d + 0,5$ if greater – maximum: 16 bar

Regulators supplied by another regulator:

Minimum and maximum supplied pressures shall be declared. Regulated pressure:

- Maximum lock up pressure $p_0 = p_d \times 1,3$
- Maximum pressure $(p_{Mp}) = p_d \times 1,2$
- Minimum pressure $(p_{Mg}) = p_d \times 0,7$

The range of an adjustable regulating device shall remain within a tolerance of $\pm 15\%$ of the nominal regulated pressure.

Regulators

iii. § 6.2.3 Variable regulators

Variable regulators may operate in a regulated pressure range specified by a minimum nominal pressure (p_{dmin}) and a maximum nominal pressure (p_{dmax}). The guaranteed flow rates at the minimum and maximum regulated pressures shall be declared.

Supply pressure:

- Regulators directly supplied at the gas container pressure:
 - Butane: minimum: 0,3 or $p_{dmax} + 0,2$ if greater – maximum: 7,5 bar
 - LPG: minimum: 0,3 or $p_{dmax} + 0,2$ if greater – maximum: 16 bar
 - Propane: minimum: 1 or $p_{dmax} + 0,5$ if greater – maximum: 16 bar
- Regulators supplied by another regulator:
 - Minimum and maximum supplied pressures shall be declared.

The performances shall be checked in the range:

Maximum regulated pressure:

$$p_o = p_{dmax} \times 1,3 \text{ or } p_{dmax} + 9 \text{ mbar if greater}$$

$$p_{Mp} = p_{dmax} \times 1,2 \text{ or } p_{dmax} + 6 \text{ mbar if greater}$$

$$p_{Mg} = p_{dmax} \times 0,7 \text{ or } p_{dmax} - 9 \text{ mbar if less than}$$

Minimum regulated pressure:

$$p_o = p_{dmin} \times 1,3 \text{ or } p_{dmin} + 9 \text{ mbar if greater}$$

$$p_{Mp} = p_{dmin} \times 1,2 \text{ or } p_{dmin} + 6 \text{ mbar if greater}$$

$$p_{Mg} = p_{dmin} \times 0,7 \text{ or } p_{dmin} - 9 \text{ mbar if less than}$$

NOTE: The requirement for the minimum regulated pressure is given in 5.1.

Safety devices

i. § A.1 Regulating devices fitted with an over-pressure relief valve of a limited flow rate (PRV)

A.1.1 Definition

An over-pressure relief valve is a safety device which vents gas to the atmosphere when the gas pressure reaches a set pressure. It closes when the pressure is reduced to below the set pressure. This valve is closed during normal operation.

A.1.2 Constructional characteristics

The relief valve shall be integral with the regulating device or be an auxiliary safety device.

It may be part of the pressure sensing subassembly of the regulating device. The adjustment of the set point shall be protected against any unauthorised modification.

For designs where gas is discharged via the pressure sensing subassembly, the respective cross sectional area of the valve, vent holes and connection pipework to the atmosphere shall be chosen in such a way that no unacceptable rise in pressure can occur within the pressure subassembly.

If the regulating device is intended to be used inside a building, enclosure or other potentially hazardous area and if the national regulations require the relief discharge to be directed to the outside, the device shall incorporate a component enabling connection to a relief, for example via an Rp 1/8 internal thread. The tube connecting to the atmosphere may also be used as a vent.

The discharge orifice shall be protected against rain water.

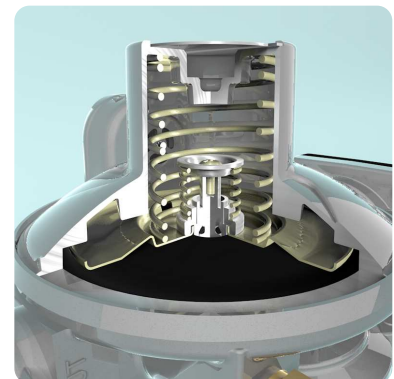

Safety devices

A.1.3.1 Regulating devices with regulated pressures specified in EN 437

The opening pressure of the relief valve shall be between 20 % above the maximum allowable lock up pressure and 150 mbar, except for regulating devices designed to operate with pressures of 112 mbar or 148 mbar where 150 mbar is replaced by 300 mbar.

The opening pressure shall be within ± 20 % of the nominal operating pressure.

At a pressure of 10 % greater than the opening measured pressure, the flow rate shall be at least 0,01 m³/h (air, under the reference conditions) or 0,1 % of the regulating device guaranteed flow rate (whichever is the greater).

At a pressure of 10 % greater than the opening measured pressure, the maximum flow rate shall not exceed 0,2 m³/h (air, under the reference conditions) or 5 % of the regulating device guaranteed flow rate (whichever is the greater).

ii. § A.2 Regulating devices fitted with an over-pressure shut off safety device (OPSO)

A.2.1 Definition

Shut off safety device, triggered by an excessive regulated pressure, which causes the complete shut off of the gas flow for all values of supply pressure.

The restoration of the gas flow shall only be possible by manual intervention when the conditions which cause the shut-off device to operate have been rectified.

The manual device which enables the restoration of the gas flow is called the resetting device.

A.2.2 Constructional characteristics

A.2.2.1 General

The shut off device may be either integral with the regulating device or be an auxiliary safety device. In any case, the constructional requirements for the shut off device are the same as those for the regulating device.

The shut off device closing mechanism, measuring device and external impulse tube if any, shall be independent of the regulating mechanism.

The shut off device closing mechanism, shall have only two positions, fully open and fully closed. This mechanism is triggered by over pressure, closing instantly.

The resetting device shall be protected against any intervention which could impair the operation of the over pressure shut off.

After shut off, the gas flow shall remain cut off at any supply pressure below the maximum supply pressure and shall be sound according to 5.5 at pressures and temperatures given in Table 18.

A.2.3 Performance characteristics

A.2.3.1 Regulating devices with regulated pressures specified in EN 437

The operating pressure of the over pressure shut off device shall be between 20 % above the maximum allowable lock up pressure and 150 mbar, except for regulating devices designed to operate with pressures of 112 mbar or 148 mbar where 150 mbar is replaced by 300 mbar.

The operating pressure shall be within ± 15 % of the nominal operating pressure.

A.2.3.2 Regulating devices with regulated pressures other than those specified in EN 437

The operating pressure of the over pressure shut off device shall be greater than 20 % above the maximum allowable lock up pressure.

The operating pressure shall be within ± 15 % of the nominal operating pressure.

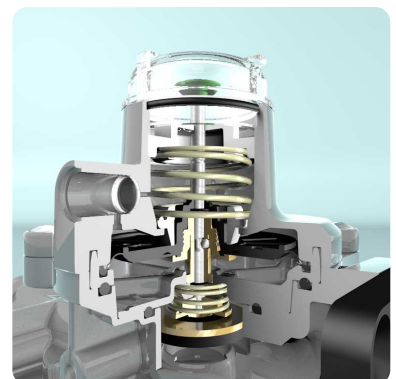

Safety devices

iii. § A.3 Regulating devices fitted with an under-pressure shut off safety device (UPSO)

A.3.1 Definition

Shut off safety device, triggered by a lack of regulated pressure, which causes the complete shut off of the gas flow for all values of supply pressure.

The components which provide the regulating function may also provide this safety function.

The restoration of the gas flow shall only be possible by manual intervention when the conditions which cause the safety device to operate have been rectified.

The manual device which enables the restoration of the flow is called the resetting device.

A.3.2 Constructional and performance characteristics

The shut-off device shall not be influenced by the operation of any other safety device.

The shut-off device shall shut off the gas flow only when the pressure measured downstream of the regulating device is equal to or greater than:

the minimum pressure required at the appliance's inlet (column " p_{min} " in Table 5) for EN 437 regulated pressures;

the pressure marked according to A.3.4 for non-EN 437 regulated pressures.

It shall be designed in such a way that, without manual intervention, it can only be in the fully open position or fully closed position. If the resetting device also acts as a manual closing valve using a rotating handle, the sense of shutting off the gas shall be clockwise.

If the resetting device has no other function and if it is accessible, it shall be protected against any intervention which could impair the regulating device's normal operation when it is reset.



iv. § A.4 Regulating devices fitted with an excess flow valve (EFV)

A.4.1 Definition

The excess flow valve is a safety device integral with the regulating device or an auxiliary safety device which causes the shut off of the gas flow for values of flow rate greater than the guaranteed flow rate for example when the downstream hose or pipe is disconnected.

The restoration of the gas flow may be by manual or automatic intervention, when the conditions which caused the safety device to operate have been rectified.

A.4.2 Performance characteristics

A.4.2.1 General requirements

The EFV shall not be influenced by the operation of any other safety device.

For devices intended to be directly connected to the gas cylinder, the following requirements shall be met with the device in its normal position and then with inclinations of $+10^\circ$ and -10° in the plane where the operation of the EFV is most influenced.

For automatic resetting EFV's, a maximum residual flow between 30 g/h and 60 g/h corresponding to the declared gas according to the national regulations is permitted.

For manual resetting EFV's, a maximum residual flow between 15 cm³/h and 200 cm³/h of air according to the national regulations is permitted.

If a manual closing device is integral with the regulating device, it is recommended that a two position manual closing device is used: one for full opening and one for complete closure in order to not influence the excess flow function.

Safety devices

A.4.2.2 Requirements for regulating devices with regulated pressures specified in EN 437

The EFV shall not shut off the gas for a flow rate less than 110 % of the guaranteed flow rate. It shall shut off the gas under the test conditions given in A.4.3.2.1 for the pressure loss given in Table 5 at the guaranteed flow rate.

A.4.2.3 Requirements for regulating devices with regulated pressures not specified in EN 437

The EFV shall shut off the gas for a flow rate between 110 % and 130 % of the guaranteed flow rate.

For variable pressure regulators this last requirement shall be met at the minimum declared regulated pressure.

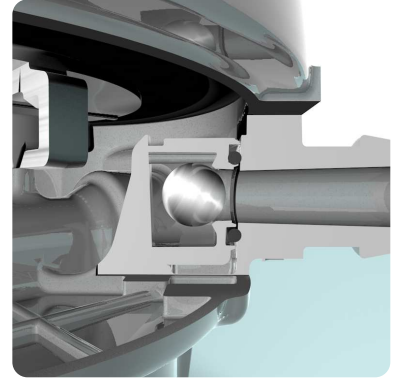

v. § A.5 Regulating devices fitted with a regulated outlet pressure limiter

A.5.1 Definition

A safety device installed downstream of the regulating function of a first stage regulating device, which in the event of a failure of the regulating function, limits the downstream pressure to a maximum specified value without shutting off the gas flow.

The pressure limiter may be either integral with the first stage regulating device or an auxiliary safety device or be independent. When independent the pressure limiter is a regulator which shall meet these additional requirements.

A.5.2 Constructional and performance characteristics

A.5.2.1 In all cases, the constructional requirements are the same as those applicable to the regulating device.

A mechanism may be provided to indicate an intervention of the limiter (i.e: test point, gauge...).

A.5.2.2 As long as the upstream pressure remains below the minimum intervention pressure of the limiter (p_{im}), the limiter shall not act.

The minimum intervention pressure of a limiter shall be equal to or greater than maximum regulated pressure of the regulator p_{Mp} as defined in Clause 6.

If the upstream pressure is greater than p_{im} whatever the flow rate, the limiter shall maintain the regulated pressure at a value not exceeding 120 % of p_{im} .

A.5.2.3 The pressure limiter shall not present a pressure loss greater than:

30 % of the nominal regulated pressure (p_d) for regulators;

10 % of the nominal regulated pressure (p_d) for automatic change over devices.



Annex G - Inlet connections

Table G.1 - Designation of connection and relation to this EN or other standards

| Type | Designation | EN 16129 | Other standards |
|------|---|----------|-------------------|
| G.1 | Threaded connection 20 x 1,814 LH - Spanner tightened | | EN 15202 |
| G.2 | Threaded connection 21,7 x 1,814 LH - 60° - Hand tightened | | EN 15202 |
| G.3 | Threaded connection M 16 x 1,5 RH - Hand tightened | | EN 15202 |
| G.4 | Threaded connection W 21,8 x 1,814 LH - 55° - Spanner tightened | | EN 15202 |
| G.5 | Threaded connection W 21,8 x 1,814 LH - Hand tightened | | EN 15202 |
| G.6 | Threaded connection W22 x 1,155 LH - Hand tightened | | EN 15202 |
| G.7 | Threaded connection G 5/8 LH - Spanner tightened | | EN 15202 |
| G.8 | Threaded connection 21,8 x 1,814 - LH - Spanner tightened | | EN 15202 |
| G.9 | Threaded connection/Nut 0,885 NGO ^a LH - Spanner tightened | | EN 15202 |
| G.10 | Threaded connection 0,885 NGO ^a LH - Rubber nose | | EN 15202 |
| G.11 | External threaded connection G 3/8 LH | | EN 560 |
| G.12 | Threaded connection W 21,8 x 1,814 LH - Hand tightened | | EN 15202 |
| G.13 | External threaded connection M 20 x 1,5 RH | X | |
| G.14 | Internal threaded connection EN 10226-1 (Rp) | | EN 10226-1 |
| G.15 | Compression fittings 8 and 10 mm of L series of EN ISO 8434-1 | | EN ISO 8434-1 |
| G.16 | Nut EN ISO 228-1 sphericonical connection | X | |
| G.17 | Nut G 3/4 flat seal tank connection | X | |
| G.18 | Internal threaded connection NPT | | ANSI/ASME B1.20.1 |
| G.19 | Threaded connection W 21,8 x 1,814 LH - Hand tightened | | EN 15202 |
| G.20 | Nut G 1/4 LH sphericonical connection | | EN 560 |
| G.21 | Threaded connection W 14,8 x 1/18 - Hand tightened | | EN 15202 |
| G.22 | Compression fittings 12, 15, 18, 22, 28, and 35 mm of L series of EN ISO 8434-1 | | EN ISO 8434-1 |
| G.23 | Internal threaded connection EN 10226-2 (Rc) | | EN 10226-2 |
| G.24 | Nut G 1/2 LH sphericonical connection | | EN 560 |
| G.25 | Threaded connection G 3/8 LH EN ISO 228-1 - Spanner tightened | | EN 15202 |
| G.26 | Nut G 3/4 sphericonical connection junction DN16 | X | |
| G.27 | Nut G 1 1/4 sphericonical connection junction DN25 | X | |
| G.28 | Nut G 3/4 flat seal line connection | X | |
| G.32 | M 14 x 1,5 self closing connection | | EN 15202 |
| G.33 | G 3/8 LH | | EN 15202 |
| G.34 | External threaded connection G 3/4 flat seal line | X | |
| G.35 | Cartridge boss valve connection | | EN 417 and EN 521 |
| G.36 | Nut M 20 x 1,5 flat seal connection | X | |
| G.37 | Internal threaded EN ISO 228-1 O-ring connection | X | |
| G.50 | Quick coupling - Diameter 16 | | EN 15202 |
| G.51 | Quick coupling - Diameter 19 | | EN 15202 |
| G.52 | Quick coupling - Diameter 20 | | EN 15202 |
| G.53 | Quick coupling - Diameter 21 | | EN 15202 |
| G.54 | Quick coupling - Diameter 22 | | EN 15202 |
| G.55 | Quick coupling - Diameter 24,5 | | EN 15202 |
| G.56 | Quick coupling - Diameter 35 | | EN 15202 |
| G.57 | Quick coupling for threaded valves 21,7 | | EN 15202 |
| G.58 | Quick coupling - Diameter 24,4 | | EN 15202 |
| G.59 | Quick coupling - Diameter 27 | | EN 15202 |
| G.60 | Quick coupling - Diameter 25,4 | | EN 15202 |
| G.61 | Quick coupling bayonet connection | | EN 15202 |
| G.67 | Quick coupling type F of EN 561 Male part | | EN 561 |

^a NGO - «National Gas Outlet» conform to ANSI/CGA V-1.

Annex H - Outlet connections

Table H.1 - Designation of connection and relation to this EN or other standards

| Type | Designation | EN 16129 | Other standards | Same drawing as |
|------|---|----------|-------------------|-----------------|
| H.1 | External threaded connection M 20 x 1,5 RH | X | | G.13 |
| H.2 | External threaded G3/8 flat seal connection | X | | |
| H.3 | External threaded G1/2 flat seal connection | X | | |
| H.4 | Nut G 1/4 LH sphericoconical connection | | EN 560 | G.20 |
| H.5 | Nut G 1/2 LH sphericoconical connection | | EN 560 | G.24 |
| H.6 | External threaded connection G 3/8 LH | | EN 560 | G.11 |
| H.7 | Internal threaded connection EN 10226-1 (Rp) | | EN 10226-1 | G.14 |
| H.8 | Compression fittings 12, 15, 18, 22, 28, and 35 mm of L series of EN ISO 8434-1 | | EN ISO 8434-1 | G.22 |
| H.9 | Compression fittings 8 and 10 mm of L series of EN ISO 8434-1 | | EN ISO 8434-1 | G.15 |
| H.10 | Nut EN ISO 228-1 sphericoconical connection | X | | G.16 |
| H.11 | Internal threaded connection NPT | | ANSI/ASME B1.20.1 | G.18 |
| H.12 | Nut G 1 1/4 flat seal DN 25 connection | X | | |
| H.13 | External threaded G 2 1/4 flat seal connection | X | | |
| H.14 | Nut gas meter flat seal cal .20 connection | X | | |
| H.15 | Nut gas meter flat seal cal .32 connection | X | | |
| H.16 | External threaded 21,8 x 1,814 LH 55° flat seal connection | X | | |
| H.17 | External threaded 21,8 x 1,814 LH 60° flat seal connection | X | | |
| H.18 | External threaded connection G 3/4 flat seal line | X | | G.34 |
| H.19 | Internal threaded connection EN 10226-2 (Rc) | | EN 10226-2 | G.23 |
| H.20 | Nut M 20 x 1,5 flat seal connection | X | | G.36 |
| H.21 | Nut 37 x 2,309 55° flat seal connection | X | | |
| H.22 | Internal threaded EN ISO 228-1 O-ring connection | X | | G.37 |
| H.50 | Hose nozzle D10 x L23,5 connection | X | | |
| H.51 | Hose nozzle D13,5 x L23 connection | X | | |
| H.52 | Hose nozzle D14 x L48 connection | X | | |
| H.53 | Hose nozzle D10 x L29 connection | X | | |
| H.54 | Hose nozzle D14 x L44 connection | X | | |
| H.55 | Hose nozzle D6,73 x L20,3 connection | X | | |
| H.56 | Quick coupling type F of EN 561 female part connection | | EN 561 | |



CAVAGNA group

Wherever gas is used, we are there

International Standards



Europe



France



Russia



Denmark



USA&Canada



USA&Canada



Australia

The products in this catalog carry the approval of National and International Organizations.

Please be so kind to verify with us approvals, accessories (tubes, tubes Material components, tuves fixing, anti-filling devices, tools for anti-filling devices, caps, sealants and setting) and optional features.
Approvals of any kind have to be expressly specified on orders or enquires.

For ordes please refer to:

Cavagna Group S.p.A. - Div. RECA
LPG & Natural Gas Regulators
Via Matteotti, 5 - 25012 Viadana di Calvisano (BS) - Italy
Tel +39 030 9688611 - Fax +39 030 9968712 - www.cavagnagroup.com



cavagna group

Wherever gas is used, we are there

Tank Regulators & accessories Residential/Commercial

| | | |
|-------------|--|-------------|
| 2.A. | 1st stage fixed HP regulator | P.18 |
| 2.B | 1st stage adjustable HP regulator | P.20 |
| 2.C. | 2nd stage fixed LP regulator | P.21 |
| 2.D. | 2nd stage adjustable LP regulator | P.22 |
| 2.E. | Twin stage fixed regulator | P.26 |
| 2.F. | Twin stage adjustable regulator | P.27 |
| | Functioning and reading of the automatic changeover | P.29 |
| 2.G. | Line pressure regulators | P.30 |
| 2.H. | Safety devices | P.31 |
| 2.I. | 1st stage HP regulator with safety devices | P.33 |
| 2.J. | 2nd stage LP regulator with safety devices | P.36 |
| 2.K. | Twin stage LP regulator with safety devices | P.39 |
| 2.L. | Kits | P.40 |
| 2.M. | Accessories | P.41 |

2.A ~ 1st Stage Fixed HP Regulators

Type 904 / 908 1st Stage Fixed Regulator

IN ACCORDANCE WITH EN 16129

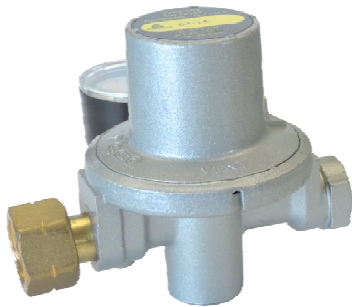

Inlet connection: G.1 - G.2 - G.4 - G.5 - G.6 - G.7 - G.9 - G.10 - G.12 - G.13 - G.14 - G.17 - G.18 - G.23 of EN 16129

Outlet connection: H.1 - H.7 - H.11 - H.19 of EN 16129

| Type of Gas | Supply Pressure (p) | Nominal Regulated Pressure* (p _a) | Nominal Flow Rate** (M _g) |
|-------------|------------------------------|---|---------------------------------------|
| PROPANE | p _a +0.5 - 16 bar | 0.75 bar 1 bar 1.5 bar 3 bar | up to 40 kg/h |

* different setting/range available on request
** depending from the regulated pressure

Type 904 - 908 regulators are designed for domestic installations.

For domestic installation outlet pressure is fixed. Do not try to modify the outlet pressure in any way.

These regulators are used in installations with two-stage regulation, with PROPANE gas contained in a tank. These regulators must be mounted as a first stage, upstream a second stage regulator.

These regulators are used when the system requires a constant supply pressure.

The regulators type 904 and 908 can be equipped with a gauge which display the outlet pressure.

For a permanent use outside the house, install the regulator in a position protected from the weather, paying great attention to the position of the vent hole.

Type 908 are equipped with a relief valve (operating pressure: depending on the regulated pressure range) (the marking "PRV" is visible on the label) and are generally not type-approved for use in closed premises (see local laws on the subject).

Materials

Body & Cover: Die cast zinc / Water painted - **Spring:** Steel - **Diaphragms:** Approved reinforced NBR - **Test port plug:** Steel

Type 984HP 1st Stage Fixed Regulator

IN ACCORDANCE WITH UL 144



Inlet connection: G.1 - G.2 - G.4 - G.5 - G.6 - G.7 - G.9 - G.10 - G.12 - G.13 - G.14 - G.17 - G.18 - G.23 of EN 16129

Outlet connection: 1/2" of H.7/H.11/H.19 of EN 16129

| Type of Gas | Supply Pressure (p) | Nominal Regulated Pressure* (p _a) | Nominal Flow Rate** (M _g) |
|-------------|------------------------------|---|---------------------------------------|
| PROPANE | p _a +0.5 - 16 bar | 0.75 bar 1 bar 1.5 bar 3 bar | up to 25 kg/h |

* different setting/range available on request
** depending from the regulated pressure

Type 984HP regulators are designed for domestic installations. For domestic installation outlet pressure is fixed. Do not try to modify the outlet pressure in any way.

These regulators are used in installations with two-stage regulation, with PROPANE gas contained in a tank. These regulators must be mounted as a first stage, upstream a second stage regulator.

These regulators are used when the system requires a constant supply pressure. These regulators are equipped with high capacity vent-hole.

The regulators type 984HP can be equipped with gauges which display the inlet and/or the outlet pressure.

For a permanent use outside the house, install the regulator in a position protected from the weather, paying great attention to the position of the vent hole.

Type 984HP can be equipped with a relief valve (operating pressure: depending on the regulated pressure range) (the marking "PRV" is visible on the label) and are generally not type-approved for use in closed premises (see local laws on the subject).

Materials

Body & Cover: Aluminum / Powder coated - **Spring:** Steel - **Diaphragms:** Approved reinforced NBR - **Test port plug:** Steel

2.A ~ 1st Stage Fixed HP Regulators

Type 944HP/948HP 1st Stage Fixed Regulator

IN ACCORDANCE WITH EN 16129



Inlet connection: 3/4" or 1" of G.14/G.18/G.23 & G.17 of EN 16129

Outlet connection: 3/4" or 1" of H.7/H.11/H.19 & H.18 of EN 16129

| Type of Gas | Supply Pressure (p) | Nominal Regulated Pressure* (p _d) | Nominal Flow Rate** (M _g) |
|-------------|------------------------------|---|---------------------------------------|
| PROPANE | p _d +0.5 - 16 bar | 0.75 bar 1.5 bar 3 bar | up to 150 kg/h |

* different setting/range available on request
** depending from the regulated pressure

Type 944HP - 948HP regulators are designed for domestic installations.

For domestic installation outlet pressure is fixed. Do not try to modify the outlet pressure in any way.

These regulators are used in installations with two-stage regulation, with PROPANE gas contained in a tank. These regulators must be mounted as a first stage, upstream a second stage regulator.

These regulators are used when the system requires a constant supply pressure. These regulators are equipped with high capacity vent-hole.

The regulators type 944HP - 948HP can be equipped with gauges which display the inlet and/or the outlet pressure.

For a permanent use outside the house, install the regulator in a position protected from the weather, paying great attention to the position of the vent hole.

Type 948HP fixed or adjustable are equipped with a relief valve (operating pressure: depending on the regulated pressure range) (the marking "PRV" is visible on the label) and are generally not type-approved for use in closed premises (see local laws on the subject).

Materials

Body & Cover: Aluminum / Powder coated - **Spring:** Steel - **Diaphragms:** Approved reinforced NBR - **Test port plug:** Steel

2.B ~ 1st Stage Adjustable HP Regulators

Type 988HP 1st Stage Adjustable Regulator

IN ACCORDANCE WITH UL 144

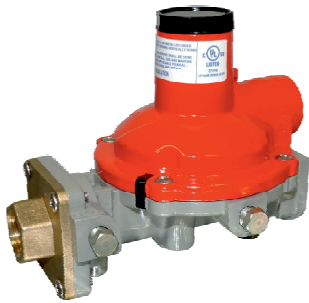

Inlet connection: G.1 - G.2 - G.4 - G.5 - G.6 - G.7 - G.9 - G.10 - G.12 - G.13 - G.14 - G.17 - G.18 - G.23 of EN 16129

Outlet connection: 1/2" or 3/4" of H.7/H.11/H.19 of EN 16129

| Type of Gas | Supply Pressure (p) | Regulated Pressure Range* (p _d) | Nominal Flow Rate** (M _g) |
|-------------|------------------------------|---|---------------------------------------|
| PROPANE | p _d +0.5 - 16 bar | 0.5 - 2 bar 0.5 - 3 bar 0.5 - 4 bar | up to 50 kg/h |

* different setting/range available on request
** depending from the regulated pressure

Type 988HP regulators are designed for domestic installations. Outlet pressure is adjustable, all adjustment must only be performed by qualified personnel, in compliance with national and European standards in force.

Final user shall not try to modify the outlet pressure in any way.

These regulators are used in installations with two-stage regulation, with PROPANE gas contained in a tank. These regulators must be mounted as a first stage, upstream a second stage regulator.

These regulators are used when the system requires a constant supply pressure. These regulators are equipped with high capacity vent-hole.

The regulators type 988HP can be equipped with gauges which display the inlet and/or the outlet pressure.

For a permanent use outside the house, install the regulator in a position protected from the weather, paying great attention to the position of the vent hole.

Type 988HP are equipped with a relief valve (operating pressure: depending on the regulated pressure range) (the marking "PRV" is visible on the label) and are generally not type-approved for use in closed premises (see local laws on the subject).

Materials

Body & Cover: Aluminum / Powder coated - **Spring:** Steel - **Diaphragms:** Approved reinforced NBR - **Test port plug:** Steel

Type 942HP/948HP 1st Stage Variable Regulator

IN ACCORDANCE WITH EN 16129 AND UL 144



Inlet connection: 3/4" or 1" of G.14/G.18/G.23 & G.17 of EN 16129

Outlet connection: 3/4" or 1" of H.7/H.11/H.19 & H.18 of EN 16129

| Type of Gas | Supply Pressure (p) | Regulated Pressure Range* (p _d) | Nominal Flow Rate** (M _g) |
|-------------|------------------------------|---|---------------------------------------|
| PROPANE | p _d +0.5 - 16 bar | 0.5 - 2 bar 0.5 - 3 bar 0.5 - 4 bar | up to 150 kg/h |

* different setting/range available on request
** depending from the regulated pressure

Type 942HP - 948HP regulators are designed for domestic installations. Outlet pressure is variable, all adjustment must only be performed by qualified personnel, in compliance with national and European standards in force.

Final user shall not try to modify the outlet pressure in any way.

These regulators are used in installations with two-stage regulation, with PROPANE gas contained in a tank. These regulators must be mounted as a first stage, upstream a second stage regulator.

These regulators are used when the system requires a constant supply pressure.

The regulators type 942HP - 948HP can be equipped with gauges which display the inlet and/or the outlet pressure.

For a permanent use outside the house, install the regulator in a position protected from the weather, paying great attention to the position of the vent hole.

Type 948HP can be equipped with a relief valve (operating pressure: depending on the regulated pressure range) (the marking "PRV" is visible on the label) and are generally not type-approved for use in closed premises (see local laws on the subject).

Materials

Body & Cover: Aluminum / Powder coated - **Spring:** Steel - **Diaphragms:** Approved reinforced NBR - **Test port plug:** Steel

2.C ~ 2nd Stage Fixed LP Regulators

Type 734/738 2nd Stage Fixed Regulator

IN ACCORDANCE WITH EN 16129

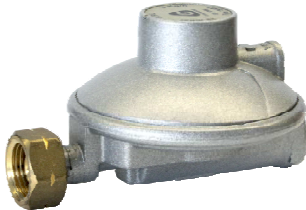

Inlet connection: G.1 - G.2 - G.4 - G.5 - G.6 - G.7 - G.8 - G.9 - G.10 - G.12 - G.13 - G.14 - G.18 - G.23 - G.34 of EN 16129

Outlet connection: H.1 - H.3 - H.7 - H.11 - H.18 - H.19 of EN 16129

| Type of Gas | Supply Pressure (p) | Nominal Regulated Pressure* (p _d) | Nominal Flow Rate** (M _g) |
|-------------|---------------------|---|---------------------------------------|
| LPG | 0.26 - 0.98 bar | 29 mbar | up to 12 kg/h |
| PROPANE | 0.49 - 1.95 bar | 37 mbar | |
| BUTANE | 1.02 - 3.9 bar | 50 mbar | |

* different setting/range available on request
** depending from the regulated pressure

Type 734 - 738 regulators are designed for domestic installations. For domestic installation outlet pressure is fixed. Do not try to modify the outlet pressure in any way.

These regulators are used in installations with two-stage regulation, they must be mounted as second stage, downstream from a first stage regulator with a outlet pressure of 0.75 bar or 1.5 bar or 3 bar.

For a permanent use outside the house, install the regulator in a position protected from the weather, paying great attention to the position of the vent hole.

Type 738 are equipped with a relief valve (operating pressure: depending on the regulated pressure range) (the marking "PRV" is visible on the label) and are generally not type-approved for use in closed premises (see local laws on the subject).

Materials

Body & Cover: Die cast zinc / Water painted - **Spring:** Steel - **Diaphragms:** Approved NBR - **Test port plug:** Steel

Type 994-4 / 998-4 2nd Stage Fixed Regulator

IN ACCORDANCE WITH EN 16129

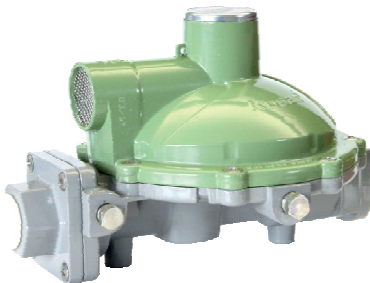

Inlet connection: G.1 - G.2 - G.4 - G.5 - G.6 - G.7 - G.9 - G.10 - G.12 - G.13 - G.14 - G.17 - G.18 - G.23 of EN 16129

Outlet connection: 1/2" or 3/4" of H.7/H.11/H.19 of EN 16129

| Type of Gas | Supply Pressure (p) | Nominal Regulated Pressure* (p _d) | Nominal Flow Rate** (M _g) |
|-------------|---------------------|---|---------------------------------------|
| LPG | 0.26 - 0.98 bar | 29 mbar | up to 30 kg/h |
| PROPANE | 0.51 - 1.95 bar | 37 mbar | |
| | 1.02 - 3.9 bar | 50 mbar | |

* different setting/range available on request
** depending from the regulated pressure

Type 994-4 / 998-4 regulators are designed for domestic installations. For domestic installation outlet pressure is fixed. Do not try to modify the outlet pressure in any way.

These regulators are used in installations with two-stage regulation, they must be mounted as second stage, downstream from a first stage regulator with a outlet pressure of 0.75 bar or 1.5 bar or 3 bar.

These regulators are used when the system requires a constant supply pressure. These regulators are equipped with high capacity vent-hole.

The regulators type 994-4 / 998-4 can be equipped with gauges which display the inlet and/or the outlet pressure.

For a permanent use outside the house, install the regulator in a position protected from the weather, paying great attention to the position of the vent hole.

Type 998-4 are equipped with a relief valve (operating pressure: depending on the regulated pressure range) (the marking "PRV" is visible on the label) and are generally not type-approved for use in closed premises (see local laws on the subject).

Materials

Body & Cover: Aluminum / Powder coated - **Spring:** Steel - **Diaphragms:** Approved NBR - **Test port plug:** Steel

2.D ~ 2nd Stage Adjustable LP Regulators

Type 733 / 738 2nd Stage Adjustable Regulator

IN ACCORDANCE WITH EN 16129

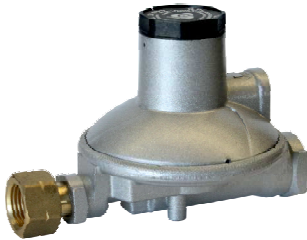

Inlet connection: G.1 - G.2 - G.4 - G.5 - G.6 - G.7 - G.8 - G.9 - G.10 - G.12 - G.13 - G.14 - G.18 - G.23 - G.34 of EN 16129

Outlet connection: H.1 - H.3 - H.7 - H.11 - H.18 - H.19 of EN 16129

| Type of Gas | Supply Pressure (p) | Regulated Pressure Range* (p _d) | Nominal Flow Rate** (M _g) |
|-------------|---------------------|---|---------------------------------------|
| LPG | 0.26 - 0.98 bar | 30 - 35 mbar | up to 12 kg/h |
| PROPANE | 0.49 - 1.95 bar | 30 - 50 mbar | |
| | 1.02 - 3.9 bar | 22 - 50 mbar | |

* different setting/range available on request
** depending from the regulated pressure

Type 733 - 738 regulators are designed for domestic installations. Outlet pressure is adjustable, all adjustment must only be performed by qualified personnel, in compliance with national and European standards in force.

Final user shall not try to modify the outlet pressure in any way.

These regulators are used in installations with two-stage regulation, they must be mounted as second stage, downstream from a first stage regulator with a outlet pressure of 0.75 bar or 1.5 bar or 3 bar.

For a permanent use outside the house, install the regulator in a position protected from the weather, paying great attention to the position of the vent hole.

Type 738 are equipped with a relief valve (operating pressure: depending on the regulated pressure range) (the marking "PRV" is visible on the label) and are generally not type-approved for use in closed premises (see local laws on the subject).

Materials

Body & Cover: Die cast zinc / Water painted - **Spring:** Steel - **Diaphragms:** Approved NBR - **Test port plug:** Steel

Type 988LP 2nd Stage Adjustable Regulator

IN ACCORDANCE WITH UL 144



Inlet connection: G.1 - G.2 - G.4 - G.5 - G.6 - G.7 - G.9 - G.10 - G.12 - G.13 - G.14 - G.17 - G.18 - G.23 of EN 16129

Outlet connection: 1/2" or 3/4" of H.7/H.11/H.19 of EN 16129

| Type of Gas | Supply Pressure (p) | Regulated Pressure Range* (p _d) | Nominal Flow Rate** (M _g) |
|-------------|---------------------|---|---------------------------------------|
| LPG | 0.26 - 0.98 bar | 30 - 35 mbar | up to 15 kg/h |
| PROPANE | 0.49 - 1.95 bar | 30 - 50 mbar | |
| | 1.02 - 3.9 bar | 22 - 50 mbar | |

* different setting/range available on request
** depending from the regulated pressure

Type 988LP regulators are designed for domestic installations. Outlet pressure is adjustable, all adjustment must only be performed by qualified personnel, in compliance with national and European standards in force.

Final user shall not try to modify the outlet pressure in any way.

These regulators are used in installations with two-stage regulation, they must be mounted as second stage, downstream from a first stage regulator with a outlet pressure of 0.75 bar or 1.5 bar or 3 bar.

These regulators are used when the system requires a constant supply pressure. These regulators are equipped with high capacity vent-hole.

The regulators type 998LP can be equipped with gauges which display the inlet and/or the outlet pressure.

For a permanent use outside the house, install the regulator in a position protected from the weather, paying great attention to the position of the vent hole.

Type 988LP are equipped with a relief valve (operating pressure: depending on the regulated pressure range) (the marking "PRV" is visible on the label) and are generally not type-approved for use in closed premises (see local laws on the subject).

Materials

Body & Cover: Aluminum / Powder coated - **Spring:** Steel - **Diaphragms:** Approved NBR - **Test port plug:** Steel

2.D ~ 2nd Stage Adjustable LP Regulators

Type 998LP 2nd Stage Adjustable Regulator

IN ACCORDANCE WITH EN 16129 AND UL 144



Inlet connection: G.1 - G.2 - G.4 - G.5 - G.6 - G.7 - G.9 - G.10 - G.12 - G.13 - G.14 - G.17 - G.18 - G.23 of EN 16129

Outlet connection: 1/2" or 3/4" of H.7/H.11/H.19 of EN 16129

| Type of Gas | Supply Pressure (p) | Regulated Pressure Range* (p _a) | Nominal Flow Rate** (M _g) |
|-------------|---------------------|---|---------------------------------------|
| LPG | 0.26 - 0.98 bar | 30 - 35 mbar | up to 30 kg/h |
| PROPANE | 0.49 - 1.95 bar | 30 - 50 mbar | |
| | 1.02 - 3.9 bar | 22 - 50 mbar | |

* different setting/range available on request
** depending from the regulated pressure

Type 998LP regulators are designed for domestic installations. Outlet pressure is adjustable, all adjustment must only be performed by qualified personnel, in compliance with national and European standards in force.

Final user shall not try to modify the outlet pressure in any way.

These regulators are used in installations with two-stage regulation, they must be mounted as second stage, downstream from a first stage regulator with a outlet pressure of 0.75 bar or 1.5 bar or 3 bar.

These regulators are used when the system requires a constant supply pressure. These regulators are equipped with high capacity vent-hole.

The regulators type 998LP can be equipped with gauges which display the inlet and/or the outlet pressure.

For a permanent use outside the house, install the regulator in a position protected from the weather, paying great attention to the position of the vent hole.

Type 998LP are equipped with a relief valve (operating pressure: depending on the regulated pressure range) (the marking "PRV" is visible on the label) and are generally not type-approved for use in closed premises (see local laws on the subject).

Materials

Body & Cover: Aluminum / Powder coated - **Spring:** Steel - **Diaphragms:** Approved NBR - **Test port plug:** Steel

Type 464 / 468 2nd Stage Adjustable Regulator (In-line version)

IN ACCORDANCE WITH EN 16129

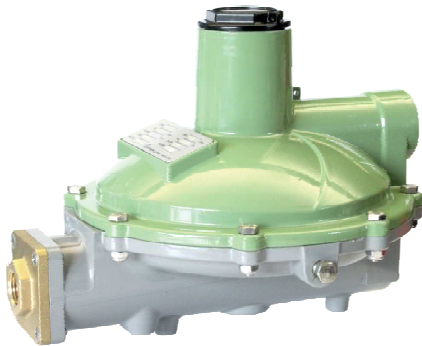

Inlet connection: 1/2" or 3/4" of G.14/G.18/G.23 of EN 16129

Outlet connection: 1" of H.7/H.11/H.19 of EN 16129

| Type of Gas | Supply Pressure (p) | Regulated Pressure Range* (p _a) | Nominal Flow Rate** (M _g) |
|-------------|---------------------|---|---------------------------------------|
| LPG | 0.45 - 1.95 bar | 25-45 mbar | up to 60 kg/h |
| PROPANE | 1 - 3 bar | 30-70 mbar | |
| | | 55-95 mbar | |
| | | 130-180 mbar | |
| | | 280-400 mbar | |

* different setting/range available on request
** depending from the regulated pressure

Type 464 / 468 regulators are designed for domestic installations. Outlet pressure is adjustable, all adjustment must only be performed by qualified personnel, in compliance with national and European standards in force.

Final user shall not try to modify the outlet pressure in any way.

These regulators are used in installations with two-stage regulation, they must be mounted as second stage, downstream from a first stage regulator with a outlet pressure of 1.5 bar or 3 bar.

These regulators are used when the system requires a constant supply pressure. These regulators are equipped with high capacity vent-hole.

The regulators type 464 / 468 can be equipped with a gauge which display the outlet pressure.

For a permanent use outside the house, install the regulator in a position protected from the weather, paying great attention to the position of the vent hole.

Type 468 are equipped with a relief valve (operating pressure: depending on the regulated pressure range) (the marking "PRV" is visible on the label) and are generally not type-approved for use in closed premises (see local laws on the subject).

Materials

Body & Cover: Aluminum / Powder coated - **Spring:** Steel - **Diaphragms:** Approved NBR - **Test port plug:** Steel

2.D ~ 2nd Stage Adjustable LP Regulators

Type 464 / 468 2nd Stage Adjustable Regulator (Flanged version)

IN ACCORDANCE WITH EN 16129 AND UL 144

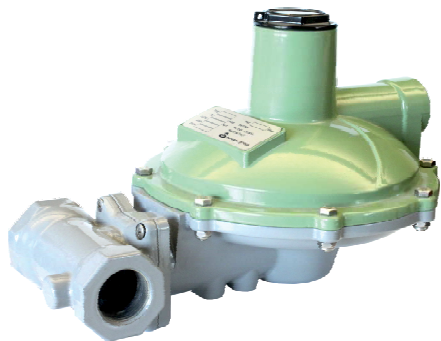

Inlet connection: 3/4" or 1" of G.14/G.18/G.23 of EN 16129

Outlet connection: 1" or 1"1/4 of H.7/H.11/H.19 of EN 16129

| Type of Gas | Supply Pressure (p) | Regulated Pressure Range* (p _a) | Nominal Flow Rate** (M _g) |
|-------------|---------------------|---|---------------------------------------|
| LPG | 0.45 - 1.95 bar | 25-45 mbar | up to 80 kg/h |
| PROPANE | 1 - 3 bar | 30-70 mbar | |
| | | 55-95 mbar | |
| | | 130-180 mbar | |
| | | 280-400 mbar | |

* different setting/range available on request
 ** depending from the regulated pressure

Type 464 / 468 regulators are designed for domestic installations. Outlet pressure is adjustable, all adjustment must only be performed by qualified personnel, in compliance with national and European standards in force.

Final user shall not try to modify the outlet pressure in any way.

These regulators are used in installations with two-stage regulation, they must be mounted as second stage, downstream from a first stage regulator with a outlet pressure of 1.5 bar or 3 bar.

These regulators are used when the system requires a constant supply pressure. These regulators are equipped with high capacity vent-hole.

The regulators type 464 / 468 can be equipped with a gauge which display the outlet pressure.

For a permanent use outside the house, install the regulator in a position protected from the weather, paying great attention to the position of the vent hole.

Type 468 are equipped with a relief valve (operating pressure: depending on the regulated pressure range) (the marking "PRV" is visible on the label) and are generally not type-approved for use in closed premises (see local laws on the subject).

Materials - Body & Cover: Aluminum/Powder coated - **Spring:** Steel - **Diaphragms:** Approved NBR - **Test port plug:** Steel - **Flange:** Cast iron/Powder coated

Type 474 / 478 2nd Stage Adjustable Regulator - Standard regulation

IN ACCORDANCE WITH EN 16129 AND UL 144



Inlet connection: 3/4" or 1" or 1"1/4 or 2" of G.14/G.18/G.23 of EN 16129

Outlet connection: 3/4" or 1" or 1"1/4 or 1"1/2 or 2" of H.7/H.11/H.19 of EN 16129

| Type of Gas | Supply Pressure (p) | Regulated Pressure Range* (p _a) | Nominal Flow Rate** (M _g) |
|-------------|---------------------|---|---------------------------------------|
| LPG | 0.49 - 1.95 bar | 25 - 45 mbar | up to 100 kg/h |
| PROPANE | 1 - 3 bar | 55 - 95 mbar | |

* different setting/range available on request
 ** depending from the regulated pressure

Type 474 / 478 regulators are designed for domestic installations. Type 474 / 478 is equipment with a 360° rotating flange. Outlet pressure is adjustable, all adjustment must only be performed by qualified personnel, in compliance with national and European standards in force.

Final user shall not try to modify the outlet pressure in any way.

These regulators are used in installations with two-stage regulation, they must be mounted as second stage, downstream from a first stage regulator with a outlet pressure of 1.5 bar or 3 bar.

These regulators are used when the system requires a constant supply pressure. These regulators are equipped with high capacity vent-hole.

The regulators type 474 / 478 can be equipped with a gauge which display the outlet pressure.

For a permanent use outside the house, install the regulator in a position protected from the weather, paying great attention to the position of the vent hole.

Type 478 are equipped with a relief valve (operating pressure: depending on the regulated pressure range) (the marking "PRV" is visible on the label) and are generally not type-approved for use in closed premises (see local laws on the subject).

Materials - Body & Cover: Aluminum/Powder coated - **Spring:** Steel - **Diaphragms:** Approved NBR - **Test port plug:** Steel - **Flange:** Cast iron/Cataphoresis treatment

2.D ~ 2nd Stage Adjustable LP Regulators

Type 474 / 478 2nd Stage Adjustable Regulator - Balanced Plug

IN ACCORDANCE WITH EN 16129 AND UL 144



Inlet connection: 3/4" or 1" or 1"1/4 or 2" of G.14/G.18/G.23 of EN 16129

Outlet connection: 3/4" or 1" or 1"1/4 or 1"1/2 or 2" of H.7/H.11/H.19 of EN 16129

| Type of Gas | Supply Pressure (p) | Regulated Pressure Range* (p _d) | Nominal Flow Rate** (M _g) |
|-------------|---------------------|---|---------------------------------------|
| LPG | 0.49 - 1.95 bar | 25-45 mbar | up to 250 kg/h |
| PROPANE | 1 - 3 bar | 55-95 mbar | |

* different setting/range available on request
 ** depending from the regulated pressure

Type 474 / 478 balanced regulators are designed for domestic installations. Type 474 / 478 is equipped with a 360° rotating flange. Outlet pressure is adjustable, all adjustment must only be performed by qualified personnel, in compliance with national and European standards in force.

Final user shall not try to modify the outlet pressure in any way.

These regulators are used in installations with two-stage regulation, they must be mounted as second stage, downstream from a first stage regulator with a outlet pressure of 1.5 bar or 3 bar.

These regulators are used when the system requires a constant supply pressure. These regulators are equipped with high capacity vent-hole. The regulators type 474 / 478 can be equipped with a gauge which display the outlet pressure.

For a permanent use outside the house, install the regulator in a position protected from the weather, paying great attention to the position of the vent hole.

Type 474/478 balanced regulators are equipped with a balanced valve that provides increased capacity.

This allows complete lockup in absence of gas flow and allows the regulator inlet pressure to change while the regulators outlet pressure holds setpoint.

Type 478 are equipped with a relief valve (operating pressure: depending on the regulated pressure range) (the marking "PRV" is visible on the label) and are generally not type-approved for use in closed premises (see local laws on the subject).

Materials - Body & Cover: Aluminum/Powder coated - **Spring:** Steel - **Diaphragms:** Approved NBR - **Test port plug:** Steel - **Flange:** Cast iron/Cataphoresis treatment

2.E ~ Twin Stage Fixed LP Regulators

Type 754TW / 758TW Twin Stage Fixed Regulator

IN ACCORDANCE WITH EN 16129 AND UL 144

Inlet connection: G.1 - G.2 - G.4 - G.5 - G.6 - G.7 - G.8 - G.9 - G.10 - G.12 - G.13 - G.14 - G.18 - G.23 - G.24 of EN 16129

Outlet connection: H.1 - H.3 - H.7 - H.11 - H.18 - H.19 of EN 16129

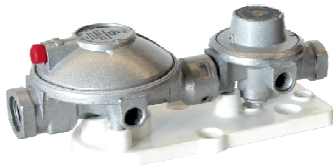

| Type of Gas | Supply Pressure (p) | Nominal Regulated Pressure* (p _d) | Nominal Flow Rate** (M _g) up to 6 kg/h |
|-------------|---------------------|---|--|
| LPG | 1 - 16 bar | 29 mbar | up to 6 kg/h |
| PROPANE | 1.2 - 16 bar | 37 mbar 50 mbar 148 mbar | |

* different setting/range available on request
** depending from the regulated pressure

Type 754TW - 758TW regulators are designed for domestic installations. For domestic installation outlet pressure is fixed. Do not try to modify the outlet pressure in any way.

The twin stage regulator is a regulator consisting of two regulation levels, which regulates the inlet pressure, coming from the withdrawal cylinder or tank directly to the inlet pressure of the user appliance.

These regulators are used when the system requires a constant supply pressure.

For a permanent use outside the house, install the regulator in a position protected from the weather, paying great attention to the position of the vent hole.

The regulators type 754TW/758TW can be equipped with gauges which display the regulated pressure (1st stage) and/or the outlet pressure. Type 758TW are equipped with a relief valve (operating pressure: depending on the regulated pressure range) (the marking "PRV" is visible on the label) and are generally not type-approved for use in closed premises (see local laws on the subject).

Materials - Body & Cover: Die cast zinc / Water painted - **Spring:** Steel - **1st stage diaphragm:** Approved reinforced NBR - **2nd stage diaphragm:** Approved NBR

Type 734C/738C Automatic Changeover Twin Stage Fixed Regulator

IN ACCORDANCE WITH EN 16129

Inlet connection: G.1 - G.2 - G.4 - G.5 - G.6 - G.7 - G.9 - G.10 - G.12 - G.13 - G.14 - G.17 - G.18 - G.23 of EN 16129

Outlet connection: H.1 - H.3 - H.7 - H.11 - H.18 - H.19 of EN 16129

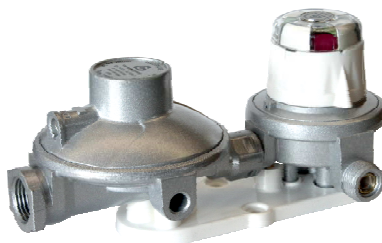

| Type of Gas | Supply Pressure (p) | Regulated Pressure Range* (p _d) | Nominal Flow Rate** (M _g) up to 12 kg/h |
|-------------|---------------------|--|---|
| PROPANE | 1 - 16 bar | 30 - 35 mbar 30 - 50 mbar 22 - 50 mbar | up to 12 kg/h |

* different setting/range available on request
** depending from the regulated pressure

Type 734C/738C regulators are designed for domestic installations. For domestic installation outlet pressure is fixed. Do not try to modify the outlet pressure in any way. Final user shall not try to modify the outlet pressure in any way.

The double stage automatic changeover regulator type 734C/738C is a combination consisting of an automatic changeover working as a 1st stage coupled to a 2nd stage regulator. The 1st stage automatic changeover works as per the paragraph "functioning of the automatic changeover", which is connected to the 2nd stage regulator: Type 734/738.

These regulators are used when the system requires a constant supply pressure.

The regulators type 734C/738C can be equipped with a gauge which display the outlet pressure. For a permanent use outside the house, install the regulator in a position protected from the weather, paying great attention to the position of the vent hole.

Type 738C are equipped with a relief valve (operating pressure: depending on the regulated pressure range) (the marking "PRV" is visible on the label) and are generally not type-approved for use in closed premises (see local laws on the subject).

Materials

Body & Cover Changeover: Die cast zinc / Water painted - **Body & Cover Second stage:** Aluminum / Powder coated - **Spring:** Steel - **1st stage diaphragm:** Approved reinforced NBR - **2nd stage diaphragm:** Approved NBR

2.F ~ Twin Stage Adjustable LP Regulators

Type 988TW Twin Stage Adjustable Regulator

IN ACCORDANCE WITH UL 144



Inlet connection: G.1 - G.2 - G.4 - G.5 - G.6 - G.7 - G.9 - G.10 - G.12 - G.13 - G.14 - G.17 - G.18 - G.23 of EN 16129

Outlet connection: 1/2" or 3/4" of H.7/H.11/H.19 of EN 16129

| Type of Gas | Supply Pressure (p) | Regulated Pressure Range* (p _d) | Nominal Flow Rate** (M _g) |
|-------------|------------------------------|--|---------------------------------------|
| PROPANE | p _d +0.5 - 16 bar | 30 - 35 mbar 30 - 50 mbar 22 - 50 mbar | up to 15 kg/h |

* different setting/range available on request
** depending from the regulated pressure

Type 988TW regulators are designed for domestic installations. Outlet pressure is adjustable, all adjustment must only be performed by qualified personnel, in compliance with national and European standards in force.

Final user shall not try to modify the outlet pressure in any way.

The twin stage regulator is a regulator consisting of two regulation levels, which regulates the inlet pressure, coming from the withdrawal cylinder or tank directly to the inlet pressure of the user appliance.

These regulators are used when the system requires a constant supply pressure. These regulators are equipped with high capacity vent-hole.

The regulators type 988TW can be equipped with gauges which display the inlet and/or the outlet pressure.

For a permanent use outside the house, install the regulator in a position protected from the weather, paying great attention to the position of the vent hole.

Type 988TW are equipped with a relief valve (operating pressure: depending on the regulated pressure range) (the marking "PRV" is visible on the label) and are generally not type-approved for use in closed premises (see local laws on the subject).

Materials - Body & Cover: Aluminum / Powder coated - **Spring:** Steel - **1st stage diaphragm:** Approved reinforced NBR - **2nd stage diaphragm:** Approved NBR - **Test port plug:** Steel

Type 998TW Twin Stage Adjustable Regulator

IN ACCORDANCE WITH EN 16129 AND UL 144



Inlet connection: G.1 - G.2 - G.4 - G.5 - G.6 - G.7 - G.9 - G.10 - G.12 - G.13 - G.14 - G.17 - G.18 - G.23 of EN 16129

Outlet connection: 1/2" or 3/4" of H.7/H.11/H.19 of EN 16129

| Type of Gas | Supply Pressure (p) | Regulated Pressure Range* (p _d) | Nominal Flow Rate** (M _g) |
|-------------|------------------------------|--|---------------------------------------|
| PROPANE | p _d +0.5 - 16 bar | 30 - 35 mbar 30 - 50 mbar 22 - 50 mbar | up to 30 kg/h |

* different setting/range available on request
** depending from the regulated pressure

Type 998TW regulators are designed for domestic installations. Outlet pressure is adjustable, all adjustment must only be performed by qualified personnel, in compliance with national and European standards in force.

Final user shall not try to modify the outlet pressure in any way.

The twin stage regulator is a regulator consisting of two regulation levels, which regulates the inlet pressure, coming from the withdrawal cylinder or tank directly to the inlet pressure of the user appliance.

These regulators are used when the system requires a constant supply pressure. These regulators are equipped with high capacity vent-hole.

The regulators type 998TW can be equipped with gauges which display the inlet and/or the outlet pressure.

For a permanent use outside the house, install the regulator in a position protected from the weather, paying great attention to the position of the vent hole.

Type 998TW are equipped with a relief valve (operating pressure: depending on the regulated pressure range) (the marking "PRV" is visible on the label) and are generally not type-approved for use in closed premises (see local laws on the subject).

Materials - Body & Cover: Aluminum / Powder coated - **Spring:** Steel - **1st stage diaphragm:** Approved reinforced NBR - **2nd stage diaphragm:** Approved NBR - **Test port plug:** Steel

2.F ~ Twin Stage Adjustable LP Regulators

Type 734TW / 738TW Twin Stage Regulator

IN ACCORDANCE WITH EN 16129 AND UL 144

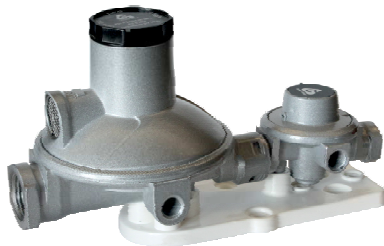

Inlet connection: G.1 - G.2 - G.4 - G.5 - G.6 - G.7 - G.8 - G.9 - G.10 - G.12 - G.13 - G.14 - G.18 - G.23 - G.24 of EN 16129

Outlet connection: H.1 - H.7 - H.11 - H.19 of EN 16129

| Type of Gas | Supply Pressure (p) | Regulated Pressure Range* (p _d) | Nominal Flow Rate** (M _g) |
|-------------|---------------------|--|---------------------------------------|
| PROPANE | 1 - 16 bar | 30 - 35 mbar 30 - 50 mbar 22 - 50 mbar | up to 12 kg/h |

* different setting/range available on request
** depending from the regulated pressure

Type 734TW/738TW regulators are designed for domestic installations. Outlet pressure is adjustable, all adjustment must only be performed by qualified personnel, in compliance with national and European standards in force.

Final user shall not try to modify the outlet pressure in any way. The twin stage regulator is a regulator consisting of two regulation levels, which regulates the inlet pressure, coming from the withdrawal cylinder or tank directly to the inlet pressure of the user appliance.

These regulators are used when the system requires a constant supply pressure.

The regulators type 734TW/738TW can be equipped with gauges which display the regulated pressure (1st stage) and/or the outlet pressure. For a permanent use outside the house, install the regulator in a position protected from the weather, paying great attention to the position of the vent hole.

Type 738TW are equipped with a relief valve (operating pressure: depending on the regulated pressure range) (the marking "PRV" is visible on the label) and are generally not type-approved for use in closed premises (see local laws on the subject).

Materials

Body & Cover: Die cast zinc / Water painted - **Spring:** Steel - **1st stage diaphragm:** Approved reinforced NBR - **2nd stage diaphragm:** Approved NBR

Type 524AC Automatic Changeover Twin Stage Adjustable Regulator

IN ACCORDANCE WITH UL 144

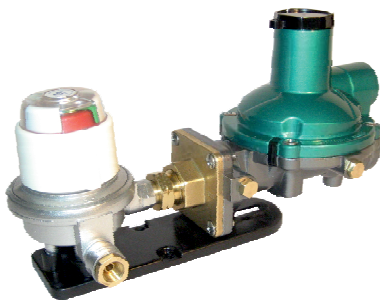

Inlet connection: G.1 - G.2 - G.4 - G.5 - G.6 - G.7 - G.9 - G.10 - G.12 - G.13 - G.14 - G.17 - G.18 - G.23 of EN 16129

Outlet connection: 1/2" or 3/4" of H.7/H.11/H.19 of EN 16129

| Type of Gas | Supply Pressure (p) | Regulated Pressure Range* (p _d) | Nominal Flow Rate** (M _g) |
|-------------|---------------------|--|---------------------------------------|
| PROPANE | 1 - 16 bar | 30 - 35 mbar 30 - 50 mbar 22 - 50 mbar | up to 12 kg/h |

* different setting/range available on request
** depending from the regulated pressure

Type 524AC regulators are designed for domestic installations. Outlet pressure is adjustable, all adjustment must only be performed by qualified personnel, in compliance with national and European standards in force.

Final user shall not try to modify the outlet pressure in any way. The double stage automatic changeover regulator type 524AC is a combination consisting of an automatic changeover working as a 1st stage coupled to a 2nd stage regulator. The 1st stage automatic changeover works as per the paragraph "functioning of the automatic changeover", which is connected to the 2nd stage regulator: Type 988 LP

These regulators are used when the system requires a constant supply pressure. These regulators are equipped with high capacity vent-hole.

The regulators type 524AC can be equipped with gauges which display the regulated pressure (1st stage) and/or the outlet pressure.

For a permanent use outside the house, install the regulator in a position protected from the weather, paying great attention to the position of the vent hole.

Type 524AC are equipped with a relief valve (operating pressure: depending on the regulated pressure range) (the marking "PRV" is visible on the label) and are generally not type-approved for use in closed premises (see local laws on the subject).

Materials - Body & Cover Changeover: Die cast zinc / Water painted - **Body & Cover Second stage:** Aluminum / Powder coated - **Spring:** Steel - **1st stage diaphragm:** Approved reinforced NBR - **2nd stage diaphragm:** Approved NBR - **Test port plug:** Steel

Functioning and reading of the automatic changeover

The automatic changeover ensures continuous gas flow, automatically changing the gas withdrawal from the exhausted "service" tank to the full "reserve" one. The full-empty indicator incorporated into the bonnet of the automatic changeover indicates the exhaustion status of the "service" tank. The indicator color changes from green to red, when the "service" tank is exhausted. The rotation of the automatic changeover handle to the full "reserve" tank restores the green color on the indicator.

Start up

- Turn two tanks' gas valves on at the same time. This is fundamental, which ensures the automatic changeover the ability to continuously supply the gas appliance, in case the service tank gets empty. The automatic changeover cannot turn to the reserve gas tank if its valve is closed.

Reading the automatic changeover's indicator: service gas tank: full

- When the two gas tanks are full, the automatic changeover's indicator turns to green while opening gas valves A and B.

- The arrow on the automatic changeover's knob indicates which one of the two gas tanks is supplying gas: that is to say the «service gas tank».

The other tank is the «reserve gas tank».

Reading the automatic changeover's indicator: service gas tank: empty

- When the service tank is getting exhausted and reaches pressure values of inversion, the automatic changeover turns automatically to the «reserve gas tank» and the gas appliance is continuously working.

In this case the automatic changeover's indicator turns to red colour: the end user gets to know that the «service gas tank» is empty: it is not supplying gas any more.

Substituting the empty gas tank

- Close the valve of the service gas tank A and turn the automatic changeover's knob 180° (see figure 3 a).

If the reserve gas tank is full and its valve is open, the automatic changeover's indicator turns to green (figure 3 b).

- Remove the empty gas tank (figure 3 c).

- Position a new full gas tank. Open the gas valve A (figure 3 d).

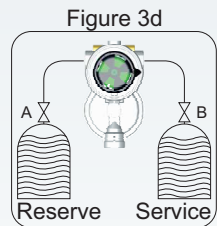
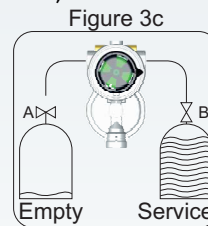
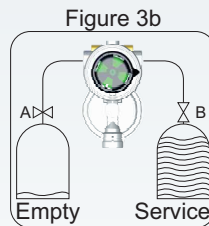
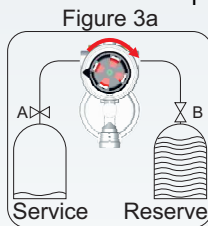
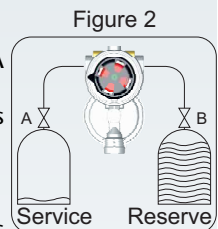
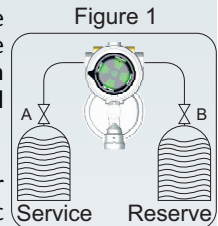

2.G ~ Line Pressure Regulators

Type 90

IN ACCORDANCE WITH CSA 6.22 AND ANSI Z21.80



- Rated inlet pressure:** 2 PSI (138 mbar) - 5PSI (345 mbar)
- Outlet pressure setting:** from 12,5 to 30 mbar
- Gases:** Natural or LP gas
- Code:** The four digit code indicates the year and the calendar week, in which the regulator was manufactured (i.e. 1712: in twelfth week of 2017)
- Ambient temp. range:** -40° / +96°C
- Pipe size NPT:** 1/2" x 1/2"
- Venting:** Vent limiter "0" 3-18 1/8" NPT
- Emergency exposure limits:** 65 PSI (4.5 BAR) inlet side only

Application: The Type 90 OARA pressure regulators are manufactured to supply the highest performances both as LINE PRESSURE REGULATORS and as GAS APPLIANCE REGULATORS.

Features

- Precise regulating control of both full flow and of tiny pilot flows.
- Manufactured in order to fulfil utility specifications for usage in residential, commercial and industrial applications.
- Regulators are supplied with a vent limiter type "0" 3-18 thread 1/8" NPT.
- Manufacturing of the regulators in terms of balancing capacity guarantees excellent control of the outlet pressure in case of absence of flow.

Materials

Body & Cover: Aluminum - **Spring:** Steel - **Diaphragms:** Approved NBR

Type 95

IN ACCORDANCE WITH CSA 6.22 AND ANSI Z21.80

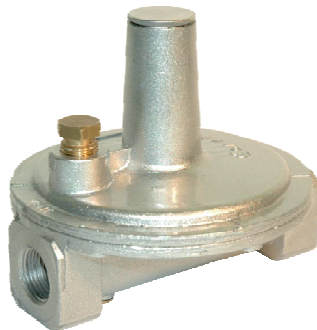

- Rated inlet pressure:** 2 PSI (138 mbar) - 5PSI (345 mbar)
- Outlet pressure setting:** from 12,5 to 30 mbar
- Gases:** Natural or LP gas
- Code:** The four digit code indicates the year and the calendar week, in which the regulator was manufactured (i.e. 1712: in twelfth week of 2017)
- Ambient temp. range:** -40° / +96°C
- Pipe size NPT:** 3/4" x 3/4" - 1" x 1"
- Venting:** Vent limiter "0" 6-38 3/8" NPT
- Emergency exposure limits:** 65 PSI (4.5 BAR) inlet side only

Application: The Type 95 OARA pressure regulators are manufactured to supply the highest performances both as LINE PRESSURE REGULATORS and as GAS APPLIANCE REGULATORS.

Features

- Precise regulating control of both full flow and of tiny pilot flows.
- All models are approved by IAS, in accordance with the two different standards.
- Manufactured in order to fulfil utility specifications for usage in residential, commercial and industrial applications.
- Regulators are supplied with a vent limiter type "0" 6-38 thread 1/8" NPT.
- Manufacturing of the regulators in terms of balancing capacity guarantees excellent control of the outlet pressure in case of absence of flow.

Materials

Body & Cover: Aluminum - **Spring:** Steel - **Diaphragms:** Approved NBR

2.H ~ Safety devices

Residential Commercial

Type 403 - Shut Off Valve Low Pressure OPSO/UPSO

IN ACCORDANCE WITH EN 16129 Annex A

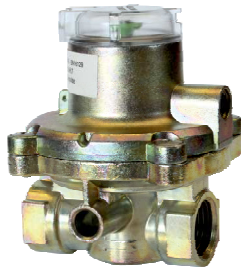

Inlet connection: 1/2" of G.14/G.18/G.23 of EN 16129

Outlet connection: 1/2" of H.7/H.11/H.19 of EN 16129

| Type of Gas | Operating pressure OPSO/UPSO* |
|-------------|-------------------------------|
| LPG | from 30 mbar to 300 mbar |
| BUTANE | |
| PROPANE | |

* different setting/range available on request
** depending from the regulated pressure

Type 403, low pressure safety device, is mainly used in gas pressure installations. This device operates as OPSO and/or UPSO valves. OPSO (Over Pressure Shut Off) device stops the gas flow in event the regulated pressure is greater than a definitive value. Such overpressures are mainly due to malfunctioning of the regulator (debris on the seat, ice blocking,...) or re-liquefaction of LPG in the pipes. UPSO (Under Pressure Shut Off) device stops the gas flow only when the pressure measured down of a definite value (see p_{min} of table 5 of EN16129).

This safety device has been designed to operate in two types of application/ installation:

1) Downstream of the supplying regulator
(**Int. impulse** is written on the label)
Supply pressure: up to 300 mbar

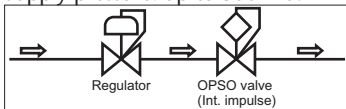

2) Upstream of the supplying regulator
(**Ext. impulse** is written on the label)
Supply pressure: up to 4 bar

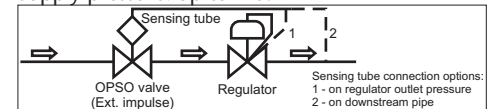

Materials

Body & Cover: Die cast zinc / Zinc plated - **Spring:** Steel - **Diaphragms:** Approved NBR

Type 404 - Shut Off Valve High Pressure OPSO

IN ACCORDANCE WITH EN 16129 Annex A

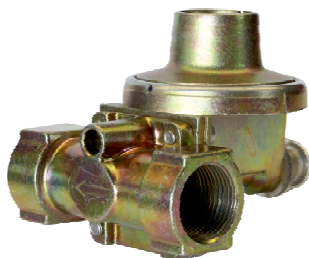

Inlet connection: 3/4" of G.14/G.18/G.23 of EN 16129

Outlet connection: 3/4" of H.7/H.11/H.19 of EN 16129

| Type of Gas | Operating pressure OPSO* |
|-------------|--------------------------|
| LPG | up to 3 bar |
| BUTANE | |
| PROPANE | |

* different setting/range available on request
** depending from the regulated pressure

Type 404, high pressure OPSO safety device, is mainly used in gas pressure installations. This Over Pressure Shut Off device stops the gas flow in event the regulated pressure is greater than a definitive value. Such overpressures are mainly due to malfunctioning of the regulator (debris on the seat, ice blocking,...) or re-liquefaction of LPG in the pipes.

This safety device has been designed to operate in two types of application/ installation:

1) Downstream of the supplying regulator
(**Int. impulse** is written on the label)
Supply pressure: up to 3 bar

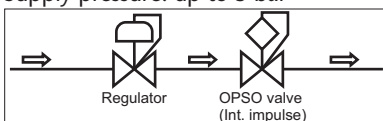

2) Upstream of the supplying regulator
(**Ext. impulse** is written on the label)
Supply pressure: up to 16 bar

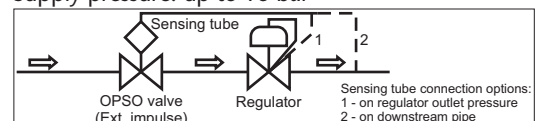

Materials

Body & Cover: Die cast zinc / Zinc plated - **Spring:** Steel - **Diaphragms:** Approved NBR

2.H ~ Safety devices

Type 954 - Limiter

IN ACCORDANCE WITH EN 16129



Inlet connection: G.1 - G.2 - G.4 - G.5 - G.6 - G.7 - G.9 - G.10 - G.12 - G.13 - G.14 - G.17 - G.18 - G.23 of EN 16129

Outlet connection: H.1 - H.7 - H.11 - H.19 of EN 16129

| Type of Gas | Supply Pressure (p) | Nominal Regulated Pressure* (p _d) | Nominal Flow Rate** (M _g) |
|-------------|------------------------------|---|---------------------------------------|
| PROPANE | p _d +0.5 - 16 bar | 1.15 bar 1.8 bar 3.6 bar | up to 40 kg/h |

* different setting/range available on request
** depending from the regulated pressure

The type 954 limiter is a safety device installed downstream of the regulating function of a first stage regulating device, which in the event of a failure of the regulating function, limits the downstream pressure to a maximum specified value without shutting off the gas flow. The outlet pressure of limiter is fixed. Do not try to modify the outlet pressure in any way. The limiter type 954 can be equipped with a gauge which display the outlet pressure. For a permanent use outside the house, install the regulator in a position protected from the weather, paying great attention to the position of the vent hole.

Materials

Body & Cover: Die cast zinc / Water painted - **Spring:** Steel - **Diaphragms:** Approved reinforced NBR - **Test port plug:** Steel

Type 944L - Limiter

IN ACCORDANCE WITH EN 16129



Inlet connection: 3/4" or 1" of G.14/G.18/G.23 & G.17 of EN 16129

Outlet connection: 3/4" or 1" of H.7/H.11/H.19 & H.18 of EN 16129

| Type of Gas | Supply Pressure (p) | Nominal Regulated Pressure* (p _d) | Nominal Flow Rate** (M _g) |
|-------------|------------------------------|---|---------------------------------------|
| PROPANE | p _d +0.5 - 16 bar | 1.15 bar 1.8 bar 3.6 bar | up to 150 kg/h |

* different setting/range available on request
** depending from the regulated pressure

The type 944L limiter is a safety device installed downstream of the regulating function of a first stage regulating device, which in the event of a failure of the regulating function, limits the downstream pressure to a maximum specified value without shutting off the gas flow. The outlet pressure of limiter is fixed. Do not try to modify the outlet pressure in any way. The limiter type 944L can be equipped with gauges which display the inlet and/or the outlet pressure. For a permanent use outside the house, install the regulator in a position protected from the weather, paying great attention to the position of the vent hole.

Materials

Body & Cover: Aluminum / Powder coated - **Spring:** Steel - **Diaphragms:** Approved reinforced NBR - **Test port plug:** Steel

2.1 ~ 1st Stage HP Regulators with safety devices

Type 522 fixed regulator with OPSO

IN ACCORDANCE WITH EN 16129



Inlet connection: G.1 - G.2 - G.4 - G.5 - G.6 - G.7 - G.9 - G.10 - G.12 - G.13 - G.14 - G.17 - G.18 - G.23 of EN 16129

Outlet connection: H.1 - H.7 - H.11 - H.19 of EN 16129

| Type of Gas | Supply Pressure (p) | Nominal Regulated Pressure* (p _d) | Nominal Flow Rate** (M _g) |
|-------------|------------------------------|---|---------------------------------------|
| PROPANE | p _d +0.5 - 16 bar | 0.75 bar | up to 20 kg/h |
| LPG | p _d +0.2 - 16 bar | | |

* different setting/range available on request
** depending from the regulated pressure

Type 522 fixed regulators are designed for industrial installations. Outlet pressure is fixed.

Do not try to modify the outlet pressure in any way.

These regulators are used when the system requires a constant supply pressure.

The regulators type 522 can be equipped with gauges which display the inlet and/or the outlet pressure.

These regulators are fitted with OPSO (over pressure shut off) device (operating pressure: depending on the regulated pressure range).

For a permanent use outside the house, install the regulator in a position protected from the weather, paying great attention to the position of the vent hole.

Materials

Body & Cover: Die cast zinc / Water painted - **Spring:** Steel - **Diaphragms:** Approved reinforced NBR - **Test port plug:** Steel

Type 522 variable regulator with OPSO

IN ACCORDANCE WITH EN 16129



Inlet connection: G.1 - G.2 - G.4 - G.5 - G.6 - G.7 - G.9 - G.10 - G.12 - G.13 - G.14 - G.17 - G.18 - G.23 of EN 16129

Outlet connection: H.1 - H.7 - H.11 - H.19 of EN 16129

| Type of Gas | Supply Pressure (p) | Regulated Pressure Range* (p _d) | Nominal Flow Rate** (M _g) |
|-------------|------------------------------|---|---------------------------------------|
| PROPANE | p _d +0.5 - 16 bar | 1 - 2 bar | up to 20 kg/h |
| LPG | p _d +0.2 - 16 bar | | |

* different setting/range available on request
** depending from the regulated pressure

Type 522 variable regulators are designed for industrial installations. Outlet pressure is variable, all adjustment must only be performed by qualified personnel, in compliance with national and European standards in force.

Final user shall not try to modify the outlet pressure in any way.

These regulators are used when the system requires a constant supply pressure.

The regulators type 522 can be equipped with gauges which display the inlet and/or the outlet pressure.

These regulators are fitted with OPSO (over pressure shut off) device (operating pressure: depending on the regulated pressure range).

For a permanent use outside the house, install the regulator in a position protected from the weather, paying great attention to the position of the vent hole.

Materials

Body & Cover: Die cast zinc / Water painted - **Spring:** Steel - **Diaphragms:** Approved reinforced NBR - **Test port plug:** Steel

2.1 ~ 1st Stage HP Regulators with safety devices

Residential Commercial

Type 902+404 variable regulator with OPSO

IN ACCORDANCE WITH EN 16129

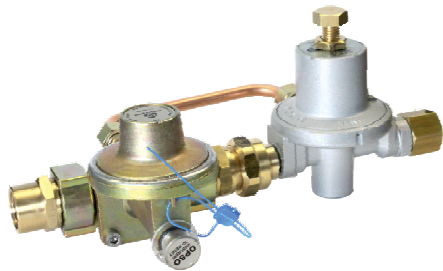

Inlet connection: 3/4" of G.14/G.18/G.23 of EN 16129

Outlet connection: H.1 - H.7 - H.11 - H.19 of EN 16129

| Type of Gas | Supply Pressure (p) | Regulated Pressure Range* (p _d) | Nominal Flow Rate** (M _g) |
|----------------|------------------------------|---|---------------------------------------|
| PROPANE LPG | p _d +0.5 - 16 bar | 0.1 - 1 bar | up to 40 kg/h |
| | p _d +0.2 - 16 bar | 0.2 - 2 bar | |
| | | 0.5 - 2 bar | |
| | | 0.5 - 3 bar | |

* different setting/range available on request
** depending from the regulated pressure

Type 902+404 regulators are designed for domestic installations. Outlet pressure is adjustable, all adjustment must only be performed by qualified personnel, in compliance with national and European standards in force.

Final user shall not try to modify the outlet pressure in any way.

These regulators are used in installations with two-stage regulation, with PROPANE gas contained in a tank. These regulators must be mounted as a first stage, upstream a second stage regulator. These regulators are used when the system requires a constant supply pressure. The regulators type 902+404 can be equipped with a gauge which display the outlet pressure.

For a permanent use outside the house, install the regulator in a position protected from the weather, paying great attention to the position of the vent hole. Type 902+404 can be equipped with a relief valve (operating pressure: depending on the regulated pressure range) (the marking "PRV" is visible on the label) and are generally not type-approved for use in closed premises (see local laws on the subject).

The OPSO device is installed upstream the first stage regulator.

Materials

Body & Cover: Die cast zinc / Water painted - **Spring:** Steel - **Diaphragms:** Approved reinforced NBR - **Test port plug:** Steel

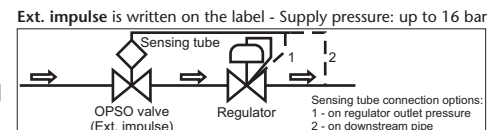

Type 942+404 variable regulator with OPSO

IN ACCORDANCE WITH EN 16129

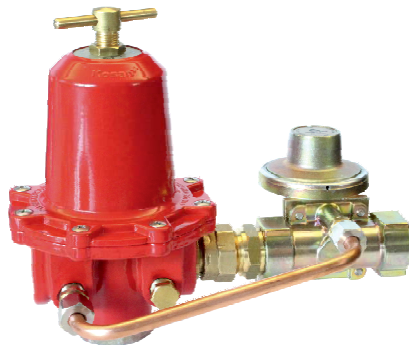

Inlet connection: 3/4" of G.14/G.18/G.23 of EN 16129

Outlet connection: 3/4" or 1" of H.7/H.11/H.19 & H.18 of EN 16129

| Type of Gas | Supply Pressure (p) | Regulated Pressure Range* (p _d) | Nominal Flow Rate** (M _g) |
|-------------|------------------------------|---|---------------------------------------|
| PROPANE | p _d +0.5 - 16 bar | 0.5 - 2 bar | up to 150 kg/h |
| | | 0.5 - 3 bar | |
| | | 0.5 - 4 bar | |
| | | | |

* different setting/range available on request
** depending from the regulated pressure

Type 942+404 regulators are designed for domestic installations. Outlet pressure is adjustable, all adjustment must only be performed by qualified personnel, in compliance with national and European standards in force.

Final user shall not try to modify the outlet pressure in any way.

These regulators are used in installations with two-stage regulation, with PROPANE gas contained in a tank. These regulators must be mounted as a first stage, upstream a second stage regulator. These regulators are used when the system requires a constant supply pressure. The regulators type 942+404 can be equipped with a gauge which display the outlet pressure.

For a permanent use outside the house, install the regulator in a position protected from the weather, paying great attention to the position of the vent hole. Type 942+404 can be equipped with a relief valve (operating pressure: depending on the regulated pressure range) (the marking "PRV" is visible on the label) and are generally not type-approved for use in closed premises (see local laws on the subject).

The OPSO device is installed upstream the first stage regulator.

Materials

Body & Cover: Aluminum / Powder coated - **Spring:** Steel - **Diaphragms:** Approved reinforced NBR - **Test port plug:** Steel

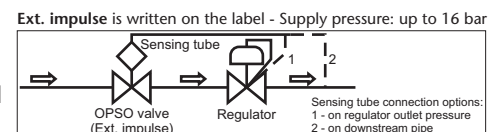

2.1 ~ 1st Stage HP Regulators with safety devices

Type 904+954 Kit 1st stage fixed regulator with limiter

IN ACCORDANCE WITH EN 16129



Inlet connection: G.1 - G.2 - G.4 - G.5 - G.6 - G.7 - G.9 - G.10 - G.12 - G.13 - G.14 - G.17 - G.18 - G.23 of EN 16129

Outlet connection: H.1 - H.7 - H.11 - H.19 of EN 16129

| Type of Gas | Supply Pressure (p) | Nominal Regulated Pressure* (p _a) | Nominal Flow Rate** (M _g) |
|-------------|------------------------------|---|---------------------------------------|
| PROPANE | p _a +0.5 - 16 bar | 0.75 bar 1 bar 1.5 bar 3 bar | up to 40 kg/h |

Operating pressure of limiter: p_a + 30%
* different setting/range available on request
 ** depending from the regulated pressure

Type 904+954 regulators are designed for domestic installations equipped with a safety device. This device is installed downstream of the regulating function of a first stage regulating device, which in the event of a failure of the regulating function, limits the downstream pressure to a maximum specified value without shutting off the gas flow.

For domestic installation outlet pressure is fixed. Do not try to modify the outlet pressure in any way.

These regulators are used in installations with two-stage regulation, with PROPANE gas contained in a tank. These regulators must be mounted as a first stage, upstream a second stage regulator.

These regulators are used when the system requires a constant supply pressure.

The regulators type 904+954 can be equipped with a gauge which display the outlet pressure.

For a permanent use outside the house, install the regulator in a position protected from the weather, paying great attention to the position of the vent hole.

Materials

Body & Cover: Die cast zinc / Water painted - **Spring:** Steel - **Diaphragms:** Approved reinforced NBR - **Test port plug:** Steel

Type 944+944L Kit 1st stage fixed regulator with limiter

IN ACCORDANCE WITH EN 16129



Inlet connection: 3/4" or 1" of G.14/G.18/G.23 & G.17 of EN 16129

Outlet connection: 3/4" or 1" of H.7/H.11/H.19 & H.18 of EN 16129

| Type of Gas | Supply Pressure (p) | Nominal Regulated Pressure* (p _a) | Nominal Flow Rate** (M _g) |
|-------------|------------------------------|---|---------------------------------------|
| PROPANE | p _a +0.5 - 16 bar | 0.75 bar 1.5 bar 3 bar | up to 150 kg/h |

Operating pressure of limiter: p_a + 30%
* different setting/range available on request
 ** depending from the regulated pressure

Type 944+944L regulators are designed for domestic installations equipped with a safety device. This device is installed downstream of the regulating function of a first stage regulating device, which in the event of a failure of the regulating function, limits the downstream pressure to a maximum specified value without shutting off the gas flow.

For domestic installation outlet pressure is fixed. Do not try to modify the outlet pressure in any way.

These regulators are used in installations with two-stage regulation, with PROPANE gas contained in a tank. These regulators must be mounted as a first stage, upstream a second stage regulator.

These regulators are used when the system requires a constant supply pressure.

The regulators type 944+944L can be equipped with gauges which display the inlet and/or the outlet pressure.

For a permanent use outside the house, install the regulator in a position protected from the weather, paying great attention to the position of the vent hole.

Materials

Body & Cover: Aluminum / Powder coated - **Spring:** Steel - **Diaphragms:** Approved reinforced NBR - **Test port plug:** Steel

2.J ~ 2nd Stage LP Regulators with safety devices

Type SP1 - SP4 ON-OFF 2nd Stage Fixed Regulator with UPSO

IN ACCORDANCE WITH EN 16129



Inlet connection: G.13 of EN 16129

Outlet connection: H.1 of EN 16129

| Type of Gas | Supply Pressure (p) | Nominal Regulated Pressure* (p _a) | Nominal Flow Rate** (M _g) |
|-------------|---------------------|---|---------------------------------------|
| PROPANE | 0.5 - 1.95 bar | 37 mbar | 1.5 kg/h 4 kg/h |

* different setting/range available on request
** depending from the regulated pressure

The Type SP1/SP4 is a second-stage, low pressure regulator suitable to be installed in double stage pressure regulated domestic installation. This regulator cannot be used as single stage regulators, but it always has to be installed after a 1st stage regulator. The Type SP1/SP4 reduces the pressure at the outlet from the 1st stage directly to the utilization pressure of the final appliances. The Type SP1/SP4 is provided with UPSO, which will operate when the installation supply pressure is insufficient and, therefore, the regulator is unable to guarantee a correct operating pressure. After activation of UPSO devices and removal of any anomalies, it is necessary to reset the safety devices by hand in order to resume the regulator correct operation.

Materials

Body & Cover: Die cast zinc / Water painted - **Spring:** Steel - **Diaphragms:** Approved reinforced NBR

Type 781 2nd Stage Fixed Regulator with OPSO/USPO

IN ACCORDANCE WITH EN 16129

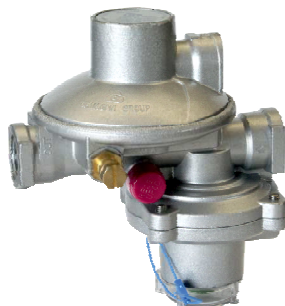

Inlet connection: G.1 - G.2 - G.4 - G.5 - G.6 - G.7 - G.10 - G.12 - G.13 - G.14 - G.18 - G.23 - G.28 of EN 16129

Outlet connection: H.3 - H.7 - H.11 - H.19 - H.56 of EN 16129

| Type of Gas | Supply Pressure (p) | Nominal Regulated Pressure* (p _a) | Nominal Flow Rate** (M _g) |
|-------------|---------------------|---|---------------------------------------|
| LPG | 0.26 - 0.98 bar | 29 mbar | up to 15 kg/h |
| PROPANE | 0.49 - 1.95 bar | 37 mbar | |
| | 1.02 - 3.9 bar | 50 mbar 100 mbar | |

* different setting/range available on request
** depending from the regulated pressure

Type 781 regulators are designed for domestic installations. For domestic installation outlet pressure is fixed. Do not try to modify the outlet pressure in any way.

These regulators are used in installations with two-stage regulation, they must be mounted as second stage, downstream from a first stage regulator with a outlet pressure of 0.75 bar or 1.5 bar or 3 bar.

For a permanent use outside the house, install the regulator in a position protected from the weather, paying great attention to the position of the vent hole.

These regulators are fitted with OPSO (over pressure shut off) device (operating pressure: depending on the regulated pressure range).

These regulators can be equipped with USPO (under pressure shut off) device (operating pressure: depending on the regulated pressure range).

Type 781 can be equipped with a relief valve (operating pressure: depending on the regulated pressure range) (the marking "PRV" is visible on the label) and are generally not type-approved for use in closed premises (see local laws on the subject).

Materials

Body & Cover: Die cast zinc / Water painted - **Spring:** Steel - **Diaphragms:** Approved NBR - **Test port plug:** Steel

2.J ~ 2nd Stage LP Regulators with safety devices

Type 998-4 - 2nd Stage Fixed Regulator with OPSO*

IN ACCORDANCE WITH EN 16129

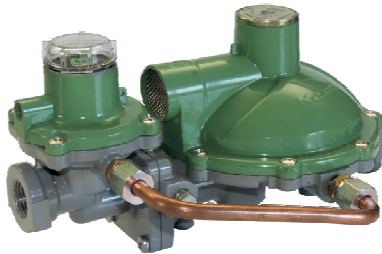

Inlet connection: 1/2" or 3/4" of G.14/G.18/G.23 of EN 16129

Outlet connection: 1/2" or 3/4" of H.7/H.11/H.19 of EN 16129

| Type of Gas | Supply Pressure (p) | Nominal Regulated Pressure* (p _a) | Nominal Flow Rate** (M _g) |
|-------------|---------------------|---|---------------------------------------|
| LPG | 0.26 - 0.98 bar | 29 mbar | up to 30 kg/h |
| PROPANE | 0.51 - 1.95 bar | 37 mbar | |
| | 1.02 - 3.9 bar | 50 mbar | |

* different setting/range available on request
 ** depending from the regulated pressure

Type 998-4 regulators are designed for domestic installations. For domestic installation outlet pressure is fixed. Do not try to modify the outlet pressure in any way.

These regulators are used in installations with two-stage regulation, they must be mounted as second stage, downstream from a first stage regulator with a outlet pressure of 0.75 bar or 1.5 bar or 3 bar.

For a permanent use outside the house, install the regulator in a position protected from the weather, paying great attention to the position of the vent hole.

The regulators type 998-4 can be equipped with a gauge which display the outlet pressure. These regulators are equipped with high capacity vent-hole.

These regulators are fitted with OPSO (over pressure shut off) device (operating pressure: depending on the regulated pressure range).

Type 998-4 can be equipped with a relief valve (operating pressure: depending on the regulated pressure range) (the marking "PRV" is visible on the label) and are generally not type-approved for use in closed premises (see local laws on the subject).

* Combined OPSO/UPSO device available.

Materials - Body & Cover: Aluminum / Powder coated - **Spring:** Steel - **Diaphragms:** Approved reinforced NBR - **Test port plug:** Steel

Type 468-4 - 2nd Stage Adjustable Regulator with OPSO*

IN ACCORDANCE WITH EN 16129



Inlet connection: 1/2" or 3/4" of G.14/G.18/G.23 of EN 16129

Outlet connection: 1" of H.7/H.11/H.19 of EN 16129

| Type of Gas | Supply Pressure (p) | Regulated Pressure Range* (p _a) | Nominal Flow Rate** (M _g) |
|-------------|---------------------|---|---------------------------------------|
| LPG | 0.26 - 0.98 bar | 25-45 mbar | up to 60 kg/h |
| PROPANE | 0.49 - 1.95 bar | 30-70 mbar | |
| | 1.02 - 3.9 bar | 55-95 mbar | |
| | | 130-180 mbar | |
| | | 280-400 mbar | |

* different setting/range available on request
 ** depending from the regulated pressure

Type 468-4 regulators are designed for domestic installations. For domestic installation outlet pressure is fixed. Do not try to modify the outlet pressure in any way.

These regulators are used in installations with two-stage regulation, they must be mounted as second stage, downstream from a first stage regulator with a outlet pressure of 0.75 bar or 1.5 bar or 3 bar.

For a permanent use outside the house, install the regulator in a position protected from the weather, paying great attention to the position of the vent hole.

The regulators type 468-4 can be equipped with a gauge which display the outlet pressure. These regulators are equipped with high capacity vent-hole.

These regulators are fitted with OPSO (over pressure shut off) device (operating pressure: depending on the regulated pressure range).

Type 468-4 is equipped with a relief valve (operating pressure: depending on the regulated pressure range) (the marking "PRV" is visible on the label) and are generally not type-approved for use in closed premises (see local laws on the subject).

* Combined OPSO/UPSO device available.

Materials - Body & Cover: Aluminum / Powder coated - **Spring:** Steel - **Diaphragms:** Approved reinforced NBR - **Test port plug:** Steel

2.J ~ 2nd Stage LP Regulators with safety devices

Type 474/478 2nd Stage Adjustable Regulator - Standard regulation with OPSO*

IN ACCORDANCE WITH EN 16129 AND UL 144

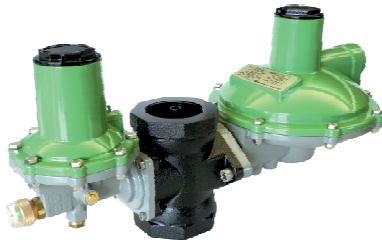

Inlet connection: 3/4" or 1" or 1"1/4 or 2" of G.14/G.18/G.23 of EN 16129

Outlet connection: 3/4" or 1" or 1"1/4 or 1"1/2 or 2" of H.7/H.11/H.19 of EN 16129

| Type of Gas | Supply Pressure (p) | Regulated Pressure Range* (p _o) | Nominal Flow Rate** (M _g) |
|-------------|---------------------|---|---------------------------------------|
| LPG | 0.49 - 1.95 bar | 25 - 45 mbar | up to 100 kg/h |
| PROPANE | 1 - 3 bar | 55 - 95 mbar | |

* different setting/range available on request
** depending from the regulated pressure

Type 474/478 regulators are designed for domestic installations. Type 474/478 is equipment with a 360° rotating flange. Outlet pressure is adjustable, all adjustment must only be performed by qualified personnel, in compliance with national and European standards in force. Final user shall not try to modify the outlet pressure in any way. These regulators are used in installations with two-stage regulation, They must be mounted as second stage, downstream from a first stage regulator with a outlet pressure of 1.5 bar or 3 bar.

These regulators are used when the system requires a constant supply pressure. These regulators are equipped with high capacity vent-hole.

The regulators type 474/478 can be equipped with a gauge which display the outlet pressure.

For a permanent use outside the house, install the regulator in a position protected from the weather, paying great attention to the position of the vent hole.

These regulators are fitted with OPSO (over pressure shut off) device (operating pressure: depending on the regulated pressure range).

Type 478 is equipped with a relief valve (operating pressure: depending on the regulated pressure range) (the marking "PRV" is visible on the label) and are generally not type-approved for use in closed premises (see local laws on the subject).

* Combined OPSO/UPSO device available.

Materials - Body & Cover: Aluminum / Powder coated - **Spring:** Steel - **Diaphragms:** Approved NBR - **Test port plug:** Steel - **Flange:** Cast iron

Type 474 / 478 2nd Stage Adjustable Regulator - Balanced Plug with OPSO*

IN ACCORDANCE WITH EN 16129 AND UL 144

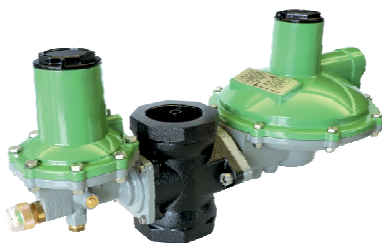

Inlet connection: 3/4" or 1" or 1"1/4 or 2" of G.14/G.18/G.23 of EN 16129

Outlet connection: 3/4" or 1" or 1"1/4 or 1"1/2 or 2" of H.7/H.11/H.19 of EN 16129

| Type of Gas | Supply Pressure (p) | Regulated Pressure Range* (p _o) | Nominal Flow Rate** (M _g) |
|-------------|---------------------|---|---------------------------------------|
| LPG | 0.49 - 1.95 bar | 25-45 mbar | up to 250 kg/h |
| PROPANE | 1 - 3 bar | 55-95 mbar | |

* different setting/range available on request
** depending from the regulated pressure

Type 474/478 balanced regulators are designed for domestic installations. Type 474/478 is equipment with a 360° rotating flange. Outlet pressure is adjustable, all adjustment must only be performed by qualified personnel, in compliance with national and European standards in force. Final user shall not try to modify the outlet pressure in any way. These regulators are used in installations with two-stage regulation, They must be mounted as second stage, downstream from a first stage regulator with a outlet pressure of 1.5 bar or 3 bar.

These regulators are used when the system requires a constant supply pressure. These regulators are equipped with high capacity vent-hole.

The regulators type 474/478 can be equipped with a gauge which display the outlet pressure.

For a permanent use outside the house, install the regulator in a position protected from the weather, paying great attention to the position of the vent hole. Type 474/478 balanced regulators are equipped with a balanced valve that provides increased capacity.

This allows complete lockup in absence of gas flow and allows the regulator inlet pressure to change while the regulators outlet pressure holds setpoint.

These regulators are fitted with OPSO (over pressure shut off) device (operating pressure: depending on the regulated pressure range).

Type 478 is equipped with a relief valve (operating pressure: depending on the regulated pressure range) (the marking "PRV" is visible on the label) and are generally not type-approved for use in closed premises (see local laws on the subject).

* Combined OPSO/UPSO device available.

Materials - Body & Cover: Aluminum / Powder coated - **Spring:** Steel - **Diaphragms:** Approved NBR - **Test port plug:** Steel - **Flange:** Cast iron

2.K ~ Twin Stage LP Regulators with safety devices

Type 782 Twin Stage Regulator with OPSO/UPSO

IN ACCORDANCE WITH EN 16129

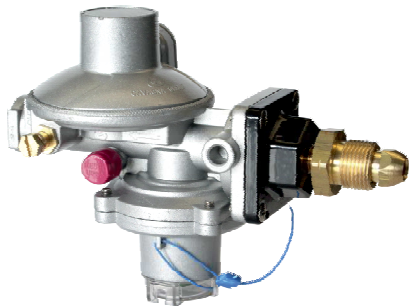

Inlet connection: G.1 - G.2 - G.4 - G.5 - G.6 - G.7 - G.10 - G.12 - G.13 - G.14 - G.18 - G.23 - G.28 of EN 16129

Outlet connection: H.3 - H.7 - H.11 - H.19 - H.56 of EN 16129

| Type of Gas | Supply Pressure (p) | Nominal Regulated Pressure* (p _d) | Nominal Flow Rate** (M _g) |
|-------------|---------------------|---|---------------------------------------|
| LPG | 0.95 - 16 bar | 29 mbar | up to 15 kg/h |
| PROPANE | 1.25 - 16 bar | 37 mbar | |
| | | 50 mbar | |
| | | 100 mbar | |

* different setting/range available on request
** depending from the regulated pressure

Type 782 regulators are designed for domestic installations. For domestic installation outlet pressure is fixed. Do not try to modify the outlet pressure in any way.

The twin stage regulator is a regulator consisting of two regulation levels, which regulates the inlet pressure, coming from the withdrawal cylinder or tank directly to the inlet pressure of the user appliance. These regulators are used when the system requires a constant supply pressure.

For a permanent use outside the house, install the regulator in a position protected from the weather, paying great attention to the position of the vent hole.

The regulators type 782 can be equipped with gauges which display the regulated pressure (1st stage) and/or the outlet pressure.

These regulators are fitted with OPSO (over pressure shut off) device (operating pressure: depending on the regulated pressure range).

These regulators can be equipped with UPSO (under pressure shut off) device (operating pressure: depending on the regulated pressure range).

Type 782 can be equipped with a relief valve (operating pressure: depending on the regulated pressure range) (the marking "PRV" is visible on the label) and are generally not type-approved for use in closed premises (see local laws on the subject).

Materials

Body & Cover: Die cast zinc / Water painted - **Spring:** Steel - **Diaphragms:** Approved NBR - **Test port plug:** Steel

Type 788 Automatic Changeover Twin Stage Fixed Regulator with OPSO

IN ACCORDANCE WITH EN 16129

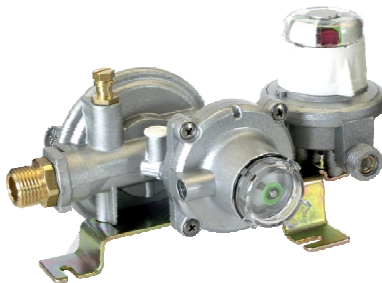

Inlet connection: G.1 - G.2 - G.4 - G.5 - G.6 - G.7 - G.9 - G.10 - G.12 - G.13 - G.14 - G.17 - G.18 - G.23 of EN 16129

Outlet connection: H.3 - H.7 - H.11 - H.19 - H.56 of EN 16129

| Type of Gas | Supply Pressure (p) | Nominal Regulated Pressure* (p _d) | Nominal Flow Rate** (M _g) |
|-------------|---------------------|---|---------------------------------------|
| PROPANE | 1 - 16 bar | 29 mbar | up to 12 kg/h |
| | | 37 mbar | |
| | | 50 mbar | |
| | | 100 mbar | |

* different setting/range available on request
** depending from the regulated pressure

Type 788 regulators are designed for domestic installations. For domestic installation outlet pressure is fixed. Do not try to modify the outlet pressure in any way. Final user shall not try to modify the outlet pressure in any way.

The double stage automatic changeover regulator type 788 is a combination consisting of an automatic changeover working as a 1st stage coupled to a 2nd stage regulator. The 1st stage automatic changeover works as per the following paragraph "functioning of the automatic changeover", which is connected to the 2nd stage regulator: Type 781. These regulators are used when the system requires a constant supply pressure. The regulators type 788 can be equipped with gauges which display the outlet pressure.

For a permanent use outside the house, install the regulator in a position protected from the weather, paying great attention to the position of the vent hole.

These regulators are fitted with OPSO (over pressure shut off) device (operating pressure: depending on the regulated pressure range).

Type 788 can be equipped with a relief valve (operating pressure: depending on the regulated pressure range) (the marking "PRV" is visible on the label) and are generally not type-approved for use in closed premises (see local laws on the subject).

Also OPSO/UPSO device available.

Materials - Body & Cover Changeover: Die cast zinc / Water painted - **Body & Cover Second stage:** Aluminum / Powder coated - **Spring:** Steel - **1st stage diaphragm:** Approved reinforced NBR - **2nd stage diaphragm:** Approved NBR

2.L ~ Kits

Type 90 + 781 + dielectric unit

On demand complete tanks kits can be developed. Different configurations can be made combining the following components:

- first stage regulator (with or without safety device)
- connecting pipe (copper hoses)
- second stage regulator (with or without safety device)
- dielectric unit
- ball valves
- connectors

The following are some examples of already developed tank kit

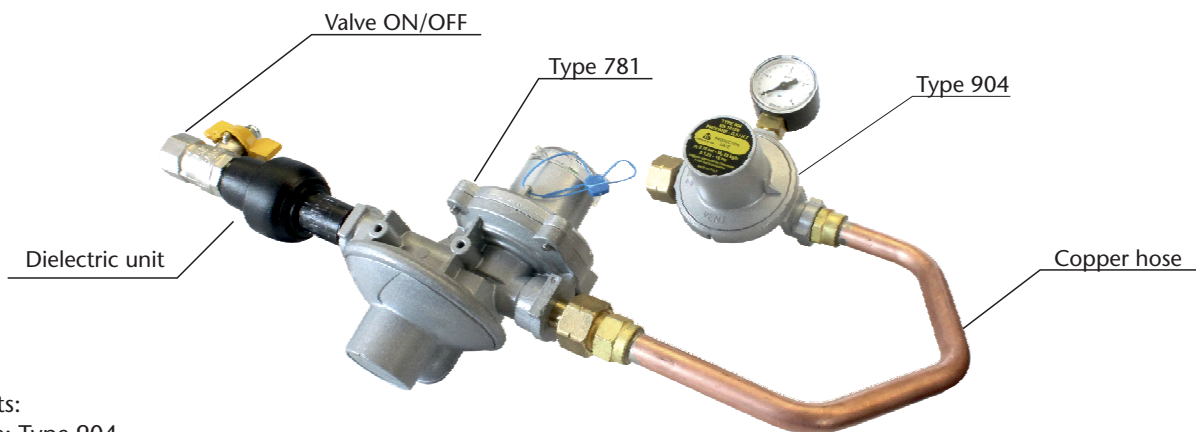

Kit elements:

- First stage: Type 904
- Copper hose with folds
- Second stage: Type 781 with OPSO device
- Dielectric unit
- Ball valve ON/OFF

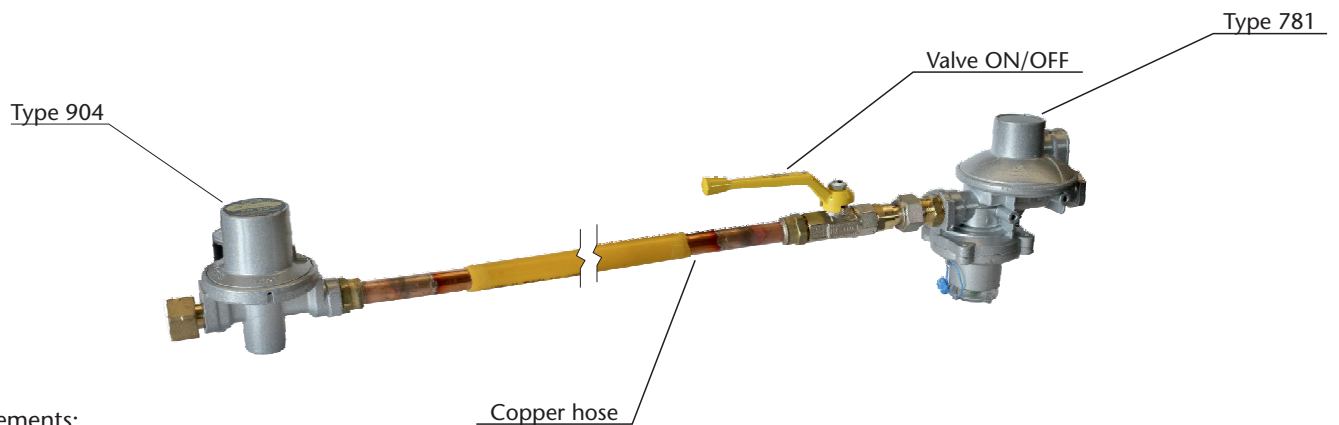

Kit elements:

- First stage: Type 904
- Copper hose straight
- Ball valve ON/OFF
- Second stage: Type 781 with OPSO device

2.M ~ Accessories

Dielectric units



Insulating joints provide electrical isolation and cathodic protection in pipeline, tanks and pumping station where petroleum, gas and water are carrier fluid. Insulating joints serve as a positive leak proof long lasting block against the flow of electrical current in all piping systems regardless of application.

Connections: Inlet: G.13 - Outlet: H.1
Materials
Body: Plastic
Fittings: Brass

| | |
|----------------------------|------------------------------|
| Electric insulation | Dielectric resistance |
| 5 MΩ | 2.5 kV |



Insulating joints provide electrical isolation and cathodic protection in pipeline, tanks and pumping station where petroleum, gas and water are carrier fluid. Insulating joints serve as a positive leak proof long lasting block against the flow of electrical current in all piping systems regardless of application. Insulating joints are manufactured in accordance with the requirements of UNI-CIG, ASTM and API. Insulating joints tested and manufactured in accordance to UNI-CIG 10284

Connections: 1/2" or 3/4" Male/Female (other connections on request)
Materials
Body: Forged steel
Isolating unit: Thermoplastic polyester elastomer

| | |
|----------------------------|------------------------------|
| Electric insulation | Dielectric resistance |
| 10 MΩ | 3.0 kV |

Vistomatic



The vistomatic indicates the exhaustion status of the tank. The indicator color changes from green to red, when the tank is exhausted. The vistomatic DOES NOT regulate the gas pressure.

Connections: Inlet: G.13 - Outlet: H.1
Materials: Body: Die cast zinc / Zinc plated

ON-OFF Valve

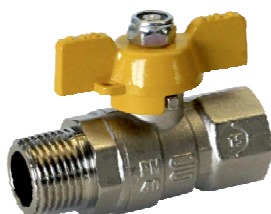

Full bore ball valve for fuel gas standard series.
 For fuel gas max 5 MOP.

Connections: 3/8" or 1/2" or 3/4" Male/Female (other connections on request)
Materials: Body: Forged brass

2.M ~ Accessories

Manifolds

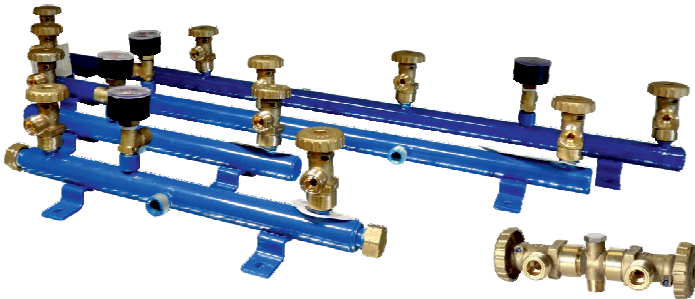

The manifolds are used to connect from two to four tanks. HP hoses are used to connect tank valves to the manifold inlets.

Brackets

Fixing brackets are available on demand. **Standard materials:** plastic, steel or zinc plated.

For metal brackets isolating components are available.

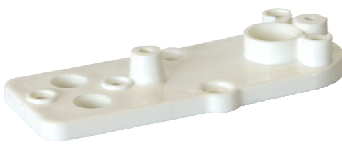

Example of plastic bracket for Type 524 AC

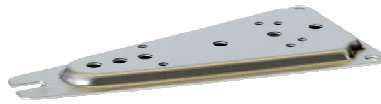

Example of steel bracket for Type 988 and 998

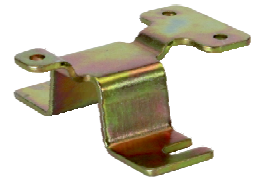

Example of zinc plated bracket for Type 734

HP Flexible hoses

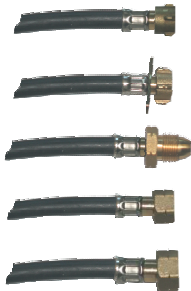

In order to complete the installation of the regulators, we have available the high pressure hose with inlet fittings suitable for all the most common cylinder valves available in Europe.

The inlet/outlet fittings of the different hoses are reinforced by ferrules made of steel crimped onto the hose, so that sealing is perfectly guaranteed.

The hoses are built in compliance with the different standards available in the countries of destination of the product.

The working pressure of the hoses for all models is 20 bar, while the checking pressure is 80 bar.

Pigtails (Copper hoses)



In order to complete the installation of the regulators, we have available the high pressure copper hose suitable for all the most common connections available in Europe.

The inlet/outlet fittings of the different hoses are welded at a maximum working temperature of 65°C. The sealing is perfectly guaranteed up to 20bar.

The pigtails are built in compliance with the different standards available in the countries of destination of the product.

The working pressure of the hoses for all models is 25 bar.

Copper pigtails are acid deep treated in order to have a bright surface finishing.



cavagna group

Wherever gas is used, we are there



Tank regulators Industrial

| | | |
|-------------|--|-------------|
| 3.A. | Single & 1st stage regulators | P.46 |
| 3.B. | 2nd stage variable regulators | P.49 |
| 3.C. | 2nd stage adjustable regulators | P.51 |



3.A ~ Single & 1st stage variable regulators

Type 812HP/818HP 1st stage variable regulator

IN ACCORDANCE WITH EN 16129 AND UL 144



Inlet connection: 3/4" or 1" or 2" of G.14/G.18/G.23 of EN 16129

Outlet connection: 3/4" or 1" or 2" of H.7/H.11/H.19 of EN 16129

| Type of Gas | Supply Pressure (p) | Regulated Pressure Range* (p _a) | Nominal Flow Rate** (M _g) |
|-------------|------------------------------|---|---------------------------------------|
| PROPANE | p _a +0.5 - 16 bar | 0.5 - 2 bar 0.5 - 3 bar 0.5 - 4 bar | up to 200 kg/h |

* different setting/range available on request
** depending from the regulated pressure

Type 812HP/818HP regulators are designed for industrial installations. Outlet pressure is variable, all adjustment must only be performed by qualified personnel, in compliance with national and European standards in force.

These regulators are used in installations with two-stage regulation, with PROPANE gas contained in a tank. These regulators must be mounted as a first stage, upstream a second stage regulator.

These regulators are used when the system requires a constant supply pressure. These regulators are equipped with high capacity vent-hole.

The regulators type 812HP/818HP can be equipped with gauges which display the inlet and/or the outlet pressure.

For a permanent outside use, install the regulator in a position protected from the weather, paying great attention to the position of the vent hole.

Type 818HP are equipped with a relief valve (operating pressure: depending on the regulated pressure range) (the marking "PRV" is visible on the label) and are generally not type-approved for use in closed premises (see local laws on the subject).

Materials

Body & Cover: Aluminum / Powder coated - **Spring:** Steel - **Diaphragms:** Approved reinforced NBR - **Test port plug:** Steel - **Flange:** Iron cast

Type 942HP/948HP 1st stage variable regulator

IN ACCORDANCE WITH EN 16129 AND UL 144



Inlet connection: 3/4" or 1" of G.14/G.18/G.23 & G.17 of EN 16129

Outlet connection: 3/4" or 1" of H.7/H.11/H.19 & H.18 of EN 16129

| Type of Gas | Supply Pressure (p) | Regulated Pressure Range* (p _a) | Nominal Flow Rate** (M _g) |
|-------------|------------------------------|---|---------------------------------------|
| PROPANE | p _a +0.5 - 16 bar | 0.5 - 2 bar 0.5 - 3 bar 0.5 - 4 bar | up to 150 kg/h |

* different setting/range available on request
** depending from the regulated pressure

Type 942HP/948HP regulators are designed for industrial installations. Outlet pressure is variable, all adjustment must only be performed by qualified personnel, in compliance with national and European standards in force.

These regulators are used in installations with two-stage regulation, with PROPANE gas contained in a tank. These regulators must be mounted as a first stage, upstream a second stage regulator.

These regulators are used when the system requires a constant supply pressure.

The regulators type 942HP/948HP can be equipped with gauges which display the inlet and/or the outlet pressure.

For a permanent outside use, install the regulator in a position protected from the weather, paying great attention to the position of the vent hole.

Type 948HP are equipped with a relief valve (operating pressure: depending on the regulated pressure range) (the marking "PRV" is visible on the label) and are generally not type-approved for use in closed premises (see local laws on the subject).

Materials

Body & Cover: Aluminum / Powder coated - **Spring:** Steel - **Diaphragms:** Approved reinforced NBR - **Test port plug:** Steel



3.A ~ Single & 1st stage variable regulators

Type 902/908 Single or 1st stage variable regulator

IN ACCORDANCE WITH EN 16129



Inlet connection: G.1 - G.2 - G.4 - G.5 - G.6 - G.7 - G.9 - G.10 - G.12 - G.13 - G.14 - G.17 - G.18 - G.23 of EN 16129

Outlet connection: H.1 - H.7 - H.11 - H.19 of EN 16129

| Type of Gas | Supply Pressure (p) | Regulated Pressure Range* (p _d) | Nominal Flow Rate** (M _g) |
|-------------|------------------------------|---|---------------------------------------|
| PROPANE | p _d +0.5 - 16 bar | 0.1 - 1 bar | up to 40 kg/h |
| LPG | p _d +0.2 - 16 bar | 0.2 - 2 bar | |
| | | 0.5 - 2 bar | |
| | | 0.5 - 3 bar | |

* different setting/range available on request
 ** depending from the regulated pressure

Type 902 regulators are designed for industrial installations. Outlet pressure is variable, all adjustment must only be performed by qualified personnel, in compliance with national and European standards in force.

High pressure regulators usually reduce tank pressure to an intermediate pressure for use by another regulator. They are also used for final stage service on particular application, as high pressure burners as well as other medium sized commercial industrial applications.

These regulators are used when the system requires a constant supply pressure.

The regulators type 902 can be equipped with a gauge which display the outlet pressure.

For a permanent outside use, install the regulator in a position protected from the weather, paying great attention to the position of the vent hole.

Type 908 are equipped with a relief valve (operating pressure: depending on the regulated pressure range) (the marking "PRV" is visible on the label) and are generally not type-approved for use in closed premises (see local laws on the subject).

Materials

Body & Cover: Die cast zinc / Water painted - **Spring:** Steel - **Diaphragms:** Approved reinforced NBR - **Test port plug:** Steel

Type 912 Single stage variable regulator

IN ACCORDANCE WITH EN 16129



Inlet connection: G.1 - G.2 - G.4 - G.5 - G.6 - G.7 - G.8 - G.9 - G.10 - G.12 - G.13 - G.14 - G.18 - G.25 - G.36 of EN 16129

Outlet connection: H.1 - H.6 - H.7 - H.11 - H.19 of EN 16129

| Type of Gas | Supply Pressure (p) | Regulated Pressure Range* (p _d) | Nominal Flow Rate** (M _g) |
|-------------|-------------------------------|---|---------------------------------------|
| PROPANE | p _d +0.5 - 16 bar | 0.5 - 1 bar | up to 14 kg/h |
| LPG | p _d +0.2 - 16 bar | 0.5 - 1.5 bar | |
| BUTANE | p _d +0.2 - 7.5 bar | 0.5 - 2 bar | |
| | | 0.5 - 4 bar | |
| | | 2 - 4 bar | |

* different setting/range available on request
 ** depending from the regulated pressure

Type 912 single stage regulators are designed for industrial installations. Outlet pressure is variable, all adjustment must only be performed by qualified personnel, in compliance with national and European standards in force.

They are used for final stage service on particular application, as high pressure burners as well as other medium sized commercial industrial applications.

They are designed to create systems different from home systems and are normally regulated by the specific standards of each country of the European Community.

The regulators type 912 can be equipped with a gauge which display the outlet pressure.

For a permanent outside use, install the regulator in a position protected from the weather, paying great attention to the position of the vent hole.

Materials

Body & Cover: Die cast zinc / Water painted - **Spring:** Steel - **Diaphragms:** Approved reinforced NBR - **Test port plug:** Steel



3.A ~ Single & 1st stage variable regulators

Type 755 Single stage variable regulator - 10 positions

IN ACCORDANCE WITH EN 16129

Inlet connection: G.1 - G.2 - G.4 - G.5 - G.6 - G.7 - G.8 - G.9 - G.10 - G.12 - G.13 - G.14 - G.18 - G.23 - G.34 of EN 16129

Outlet connection: H.1 - H.3 - H.7 - H.11 - H.18 - H.19 of EN 16129



| Type of Gas | Supply Pressure (p) | Regulated Pressure Range* (p _d) | Nominal Flow Rate** (M _g) |
|-------------|-------------------------------|---|---------------------------------------|
| PROPANE | p _d +0.5 - 16 bar | 50 - 150 mbar | up to 4 kg/h |
| LPG | p _d +0.2 - 16 bar | 50 - 200 mbar | |
| BUTANE | p _d +0.2 - 7.5 bar | 200 - 500 mbar | |

* different setting/range available on request
 ** depending from the regulated pressure

Type 755 regulators single stage are designed for industrial installations. Outlet pressure is variable in 10 positions, all adjustment must only be performed by qualified personnel, in compliance with national and European standards in force.

They are used for final stage service on particular application, as high pressure burners as well as other medium sized commercial industrial applications.

They are designed to create systems different from home systems and are normally regulated by the specific standards of each country of the European Community.

These regulators are used when the system requires a constant supply pressure.

The regulators type 755 can be equipped with a gauge which display the outlet pressure.

For a permanent outside use, install the regulator in a position protected from the weather, paying great attention to the position of the vent hole.

Materials

Body & Cover: Die cast zinc / Water painted - **Spring:** Steel - **Diaphragms:** Approved NBR - **Test port plug:** Steel



3.B ~ 2nd stage variable regulators

Type 752 - 2nd stage variable regulator

IN ACCORDANCE WITH EN 16129



Inlet connection: G.1 - G.2 - G.4 - G.5 - G.6 - G.7 - G.8 - G.9 - G.10 - G.12 - G.13 - G.14 - G.18 - G.23 - G.34 of EN 16129

Outlet connection: H.1 - H.3 - H.7 - H.11 - H.18 - H.19 of EN 16129

| Type of Gas | Supply Pressure (p) | Regulated Pressure Range* (p _a) | Nominal Flow Rate** (M _g) |
|-------------|---------------------|---|---------------------------------------|
| PROPANE | 0.26 - 0.98 bar | 10 - 60 mbar | up to 4 kg/h |
| LPG | 0.49 - 1.95 bar | 20 - 80 mbar | |
| BUTANE | 1.02 - 3.9 bar | 30 - 150 mbar | |
| | | 30 - 300 mbar | |

* different setting/range available on request
 ** depending from the regulated pressure

Type 752 regulators are designed for industrial installations. Outlet pressure is variable, all adjustment must only be performed by qualified personnel, in compliance with national and European standards in force.

These regulators are used in installations with two-stage regulation, they must be mounted as second stage, downstream from a first stage regulator with a outlet pressure of 0.75 bar or 1.5 bar or 3 bar.

The regulators type 752 can be equipped with a gauge which display the outlet pressure.

For a permanent use outside the house, install the regulator in a position protected from the weather, paying great attention to the position of the vent hole.

Materials

Body & Cover: Die cast zinc / Water painted - **Spring:** Steel - **Diaphragms:** Approved NBR - **Test port plug:** Steel

Type 732 - 2nd stage variable regulator

IN ACCORDANCE WITH EN 16129



Inlet connection: G.1 - G.2 - G.4 - G.5 - G.6 - G.7 - G.8 - G.9 - G.10 - G.12 - G.13 - G.14 - G.18 - G.23 - G.34 of EN 16129

Outlet connection: H.1 - H.3 - H.7 - H.11 - H.18 - H.19 of EN 16129

| Type of Gas | Supply Pressure (p) | Regulated Pressure Range* (p _a) | Nominal Flow Rate** (M _g) |
|-------------|---------------------|---|---------------------------------------|
| PROPANE | 0.26 - 0.98 bar | 10 - 60 mbar | up to 12 kg/h |
| LPG | 0.49 - 1.95 bar | 20 - 80 mbar | |
| BUTANE | 1.02 - 3.9 bar | 30 - 150 mbar | |
| | | 30 - 300 mbar | |

* different setting/range available on request
 ** depending from the regulated pressure

Type 732 regulators are designed for industrial installations. Outlet pressure is variable, all adjustment must only be performed by qualified personnel, in compliance with national and European standards in force.

These regulators are used in installations with two-stage regulation, they must be mounted as second stage, downstream from a first stage regulator with a outlet pressure of 0.75 bar or 1.5 bar or 3 bar.

The regulators type 732 can be equipped with a gauge which display the outlet pressure.

For a permanent use outside the house, install the regulator in a position protected from the weather, paying great attention to the position of the vent hole.

Materials

Body & Cover: Die cast zinc / Water painted - **Spring:** Steel - **Diaphragms:** Approved NBR - **Test port plug:** Steel



3.B ~ 2nd stage variable regulators

Type 992 - 2nd stage variable regulator

IN ACCORDANCE WITH EN 16129



Inlet connection: G.1 - G.2 - G.4 - G.5 - G.6 - G.7 - G.9 - G.10 - G.12 - G.13 - G.14 - G.17 - G.18 - G.23 of EN 16129

Outlet connection: 1/2" or 3/4" of H.7/H.11/H.19 of EN 16129

| Type of Gas | Supply Pressure (p) | Regulated Pressure Range* (p _a) | Nominal Flow Rate** (M _g) |
|-------------|---------------------|---|---------------------------------------|
| PROPANE | 0.26 - 0.98 bar | 30 - 180 mbar | up to 35 kg/h |
| LPG | 0.49 - 1.95 bar | 40 - 300 mbar | |
| | 1.02 - 3.9 bar | | |

* different setting/range available on request
 ** depending from the regulated pressure

Type 992 regulators are designed for industrial installations. Outlet pressure is variable, all adjustment must only be performed by qualified personnel, in compliance with national and European standards in force.

These regulators are used in installations with two-stage regulation, They must be mounted as second stage, downstream from a first stage regulator with a outlet pressure of 0.75 bar or 1.5 bar or 3 bar.

These regulators are used when the system requires a constant supply pressure. These regulators are equipped with high capacity vent-hole.

The regulators type 992 can be equipped with gauges which display the inlet and/or the outlet pressure.

For a permanent use outside the house, install the regulator in a position protected from the weather, paying great attention to the position of the vent hole.

Materials

Body & Cover: Aluminum / Powder coated - **Spring:** Steel - **Diaphragms:** Approved NBR - **Test port plug:** Steel

Type 462 - 2nd stage variable regulator

IN ACCORDANCE WITH EN 16129



Inlet connection: 1/2" or 3/4" of G.14/G.18/G.23 of EN 16129

Outlet connection: 1" of H.7/H.11/H.19 of EN 16129

| Type of Gas | Supply Pressure (p) | Regulated Pressure Range* (p _a) | Nominal Flow Rate** (M _g) |
|-------------|---------------------|---|---------------------------------------|
| PROPANE | 0.45 - 3.9 bar | 10 - 200 mbar | up to 80 kg/h |
| | | 30 - 300 mbar | |
| | | 50 - 300 mbar | |

* different setting/range available on request
 ** depending from the regulated pressure

Type 462 regulators are designed for industrial installations. Outlet pressure is variable, all adjustment must only be performed by qualified personnel, in compliance with national and European standards in force.

These regulators are used in installations with two-stage regulation, They must be mounted as second stage, downstream from a first stage regulator with a outlet pressure of 0.75 bar or 1.5 bar or 3 bar.

These regulators are used when the system requires a constant supply pressure. These regulators are equipped with high capacity vent-hole.

The regulators type 462 can be equipped with a gauge which display the outlet pressure.

For a permanent use outside the house, install the regulator in a position protected from the weather, paying great attention to the position of the vent hole.

Flanged version available upon request.

Materials

Body & Cover: Aluminum / Powder coated - **Spring:** Steel - **Diaphragms:** Approved NBR - **Test port plug:** Steel



3.C ~ 2nd stage adjustable regulators

Type 753 / 758 - 2nd stage adjustable regulator

IN ACCORDANCE WITH EN 16129

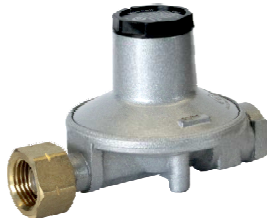

Inlet connection: G.1 - G.2 - G.4 - G.5 - G.6 - G.7 - G.8 - G.9 - G.10 - G.12 - G.13 - G.14 - G.18 - G.23 - G.34 of EN 16129

Outlet connection: H.1 - H.3 - H.7 - H.11 - H.18 - H.19 of EN 16129

| Type of Gas | Supply Pressure (p) | Regulated Pressure Range* (p _d) | Nominal Flow Rate** (M _g) |
|-------------|---------------------|---|---------------------------------------|
| LPG | 0.26 - 0.98 bar | 30 - 35 mbar | up to 4 kg/h |
| PROPANE | 0.49 - 1.95 bar | 30 - 50 mbar | |
| | 1.02 - 3.9 bar | 22 - 50 mbar | |

* different setting/range available on request
** depending from the regulated pressure

Type 753/758 regulators are designed for domestic installations. Outlet pressure is adjustable, all adjustment must only be performed by qualified personnel, in compliance with national and European standards in force.

These regulators are used in installations with two-stage regulation, They must be mounted as second stage, downstream from a first stage regulator with a outlet pressure of 0.75 bar or 1.5 bar or 3 bar.

For a permanent use outside the house, install the regulator in a position protected from the weather, paying great attention to the position of the vent hole.

Type 758 are equipped with a relief valve (operating pressure: depending on the regulated pressure range) (the marking "PRV" is visible on the label) and are generally not type-approved for use in closed premises (see local laws on the subject).

Materials

Body & Cover: Die cast zinc / Water painted - **Spring:** Steel - **Diaphragms:** Approved NBR - **Test port plug:** Steel

Type 733 / 738 - 2nd stage adjustable regulator

IN ACCORDANCE WITH EN 16129

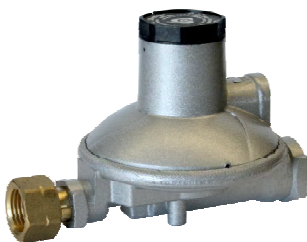

Inlet connection: G.1 - G.2 - G.4 - G.5 - G.6 - G.7 - G.8 - G.9 - G.10 - G.12 - G.13 - G.14 - G.18 - G.23 - G.34 of EN 16129

Outlet connection: H.1 - H.3 - H.7 - H.11 - H.18 - H.19 of EN 16129

| Type of Gas | Supply Pressure (p) | Regulated Pressure Range* (p _d) | Nominal Flow Rate** (M _g) |
|-------------|---------------------|---|---------------------------------------|
| LPG | 0.26 - 0.98 bar | 30 - 35 mbar | up to 12 kg/h |
| PROPANE | 0.49 - 1.95 bar | 30 - 50 mbar | |
| | 1.02 - 3.9 bar | 22 - 50 mbar | |

* different setting/range available on request
** depending from the regulated pressure

Type 733/738 regulators are designed for domestic installations. Outlet pressure is adjustable, all adjustment must only be performed by qualified personnel, in compliance with national and European standards in force.

These regulators are used in installations with two-stage regulation, They must be mounted as second stage, downstream from a first stage regulator with a outlet pressure of 0.75 bar or 1.5 bar or 3 bar.

For a permanent use outside the house, install the regulator in a position protected from the weather, paying great attention to the position of the vent hole.

Type 738 are equipped with a relief valve (operating pressure: depending on the regulated pressure range) (the marking "PRV" is visible on the label) and are generally not type-approved for use in closed premises (see local laws on the subject).

Materials

Body & Cover: Die cast zinc / Water painted - **Spring:** Steel - **Diaphragms:** Approved NBR - **Test port plug:** Steel



3.C ~ 2nd stage adjustable regulators

Type 998LP 2nd Stage Adjustable Regulator

IN ACCORDANCE WITH EN 16129 AND UL 144



Inlet connection: G.1 - G.2 - G.4 - G.5 - G.6 - G.7 - G.9 - G.10 - G.12 - G.13 - G.14 - G.17 - G.18 - G.23 of EN 16129

Outlet connection: 1/2" or 3/4" of H.7/H.11/H.19 of EN 16129

| Type of Gas | Supply Pressure (p) | Regulated Pressure Range* (p _a) | Nominal Flow Rate** (M _g) |
|-------------|---------------------|---|---------------------------------------|
| LPG | 0.26 - 0.98 bar | 30 - 35 mbar | up to 30 kg/h |
| PROPANE | 0.49 - 1.95 bar | 30 - 50 mbar | |
| | 1.02 - 3.9 bar | 22 - 50 mbar | |

* different setting/range available on request
 ** depending from the regulated pressure

Type 998LP regulators are designed for industrial installations. Outlet pressure is adjustable, all adjustment must only be performed by qualified personnel, in compliance with national and European standards in force.

These regulators are used in installations with two-stage regulation, They must be mounted as second stage, downstream from a first stage regulator with a outlet pressure of 0.75 bar or 1.5 bar or 3 bar.

These regulators are used when the system requires a constant supply pressure. These regulators are equipped with high capacity vent-hole.

The regulators type 998LP can be equipped with gauges which display the inlet and/or the outlet pressure.

For a permanent use outside the house, install the regulator in a position protected from the weather, paying great attention to the position of the vent hole.

Type 998LP can be equipped with a relief valve (operating pressure: depending on the regulated pressure range) (the marking "PRV" is visible on the label) and are generally not type-approved for use in closed premises (see local laws on the subject).

Materials

Body & Cover: Aluminum / Powder coated - **Spring:** Steel - **Diaphragms:** Approved NBR - **Test port plug:** Steel

Type 464/468 2nd Stage Adjustable Regulator

IN ACCORDANCE WITH EN 16129

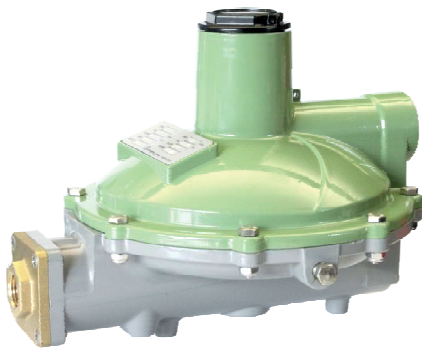

Inlet connection: 1/2" or 3/4" of G.14/G.18/G.23 of EN 16129

Outlet connection: 1" of H.7/H.11/H.19 of EN 16129

| Type of Gas | Supply Pressure (p) | Regulated Pressure Range* (p _a) | Nominal Flow Rate** (M _g) |
|-------------|---------------------|---|---------------------------------------|
| LPG | 0.45 - 1.95 bar | 25-45 mbar | up to 60 kg/h |
| PROPANE | 1 - 3 bar | 30-70 mbar | |
| | | 55-95 mbar | |
| | | 130-180 mbar | |
| | | 280-400 mbar | |

* different setting/range available on request
 ** depending from the regulated pressure

Type 464 / 468 regulators are designed for industrial installations. Outlet pressure is adjustable, all adjustment must only be performed by qualified personnel, in compliance with national and European standards in force.

These regulators are used in installations with two-stage regulation, They must be mounted as second stage, downstream from a first stage regulator with a outlet pressure of 1.5 bar or 3 bar.

These regulators are used when the system requires a constant supply pressure. These regulators are equipped with high capacity vent-hole.

The regulators type 464 / 468 can be equipped with a gauge which display the outlet pressure.

For a permanent use outside the house, install the regulator in a position protected from the weather, paying great attention to the position of the vent hole.

Type 468 are equipped with a relief valve (operating pressure: depending on the regulated pressure range) (the marking "PRV" is visible on the label) and are generally not type-approved for use in closed premises (see local laws on the subject).

Materials

Body & Cover: Aluminum / Powder coated - **Spring:** Steel - **Diaphragms:** Approved NBR - **Test port plug:** Steel



3.C ~ 2nd stage adjustable regulators

Type 464 / 468 2nd Stage Adjustable Regulator (Flanged version)

IN ACCORDANCE WITH EN 16129 AND UL 144

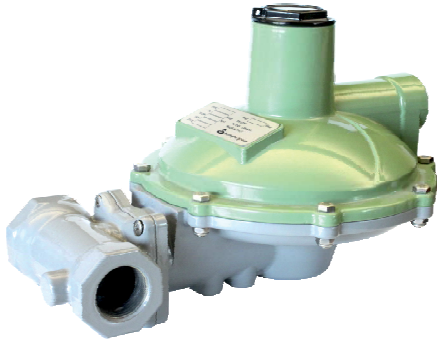

Inlet connection: 3/4" or 1" of G.14/G.18/G.23 of EN 16129

Outlet connection: 1" or 1"1/4 of H.7/H.11/H.19 of EN 16129

| Type of Gas | Supply Pressure (p) | Regulated Pressure Range* (p _o) | Nominal Flow Rate** (M _g) |
|-------------|---------------------|--|---------------------------------------|
| LPG | 0.45 - 1.95 bar | 25-45 mbar | up to 80 kg/h |
| PROPANE | 1 - 3 bar | 30-70 mbar 55-95 mbar 130-180 mbar 280-400 mbar | |

* different setting/range available on request
** depending from the regulated pressure

Type 464 / 468 regulators are designed for industrial installations. Outlet pressure is adjustable, all adjustment must only be performed by qualified personnel, in compliance with national and European standards in force.

Final user shall not try to modify the outlet pressure in any way.

These regulators are used in installations with two-stage regulation, They must be mounted as second stage, downstream from a first stage regulator with a outlet pressure of 1.5 bar or 3 bar.

These regulators are used when the system requires a constant supply pressure. These regulators are equipped with high capacity vent-hole.

The regulators type 464 / 468 can be equipped with a gauge which display the outlet pressure.

For a permanent use outside the house, install the regulator in a position protected from the weather, paying great attention to the position of the vent hole.

Type 468 are equipped with a relief valve (operating pressure: depending on the regulated pressure range) (the marking "PRV" is visible on the label) and are generally not type-approved for use in closed premises (see local laws on the subject).

Materials

Body & Cover: Aluminum / Powder coated - **Spring:** Steel - **Diaphragms:** Approved NBR - **Test port plug:** Steel - **Flange:** Cast iron / Powder coated



cavagna group

Wherever gas is used, we are there

Tank installations National guidelines (examples)

| | | | |
|------|---------|---|------|
| 4.A. | Italy |  | P.56 |
| 4.B. | France |  | P.58 |
| 4.C. | UK |  | P.59 |
| 4.D. | Belgium |  | P.60 |

4.A ~ Italy

UNI 7131/2014 §7 - Installation of an appliance supplied by a domestic LPG storage or similar and installation of the related regulation kit

UNI 7131/2014 Italian standard defines requirements of appliances supplied by LPG tanks for domestic or similar usage, and requirements about related regulation kits.

Gas pressure must be decreased in at least two reducing stages. The supply pressure of the second stage regulator cannot be higher than 1.5 bar. This allows to use 5th category tubing at the outlet of the first stage regulator, according to UNI 9165 standard.

Pressure regulators and related safety devices, which are installed to decrease the working pressure and keep it constant, must be designed, produced and tested in accordance with EN16129 standard.

First stage regulator

The first stage regulator is connected directly to the service regulation kit of the tank. Outlet nominal pressure is fixed and set at 0.75 bar by the producer. The declared supply pressure for "propane regulators" is 1.25 bar minimum pressure, and 16 bar maximum pressure.

The first stage regulator must assure at least a capacity of 20 kg/h or a value equal to 120% of the total maximum pressure declared on the user's appliance.

First stage over pressure safety devices

If the second stage regulator is installed close to the walls of a building, the first stage regulator must be equipped with a device against over pressure, in accordance with requirements specified in A2 (OPSO Shut off valve) or A5 (Pressure limiter device).

If the second stage regulator is installed near a first stage regulator not equipped with an OPSO shut-off valve nor a pressure limiter, the hose tubing must be suitable for pressures higher or equal to 16 bar.

Second stage regulator

The second stage regulator has to assure a pressure range fit for the group of appliances it needs to supply.

The nominal outlet pressure of the second stage regulator must be fixed and set at 37 mbar.

Performances of the second stage regulator have to allow not to exceed limits declared by the EN16129 standard, taking into account a maximum allowed pressure drop of 5 mbar between the second stage regulator and the appliances of usage.

The second stage regulator has to assure a minimum capacity of 5 kg/h for each user's appliance (installations requiring power not higher than 70 kW).

Installation of the second stage regulator

Second stage regulators can be mounted close to buildings' walls, only if compulsory conditions of manufacture required by the standard are respected. The cover's vent hole must be turned downwards, so that no condensation becomes stagnant. For safety purposes the second stage regulator must be positioned higher than the immediately downstream gas hose pipe.

The regulator must be protected from the elements, from water, dust, flood or from any other weather agent that could damage its functionality.

Second stage regulator's safety devices

The second stage regulator must be equipped with one or more safety devices in accordance with EN16129 standard: working pressure cannot be higher than 150 mbar.

To assure that the working pressure does not exceed 150 mbar, an overpressure safety valve, set at limited capacity, must be used (PRV Pressure Relief Valve, as per the EN16129 standard's A1 attachment) combined with an over pressure shut-off device (OPSO, as per the EN16129 A2 attachment).

Plants classification - UNI9860 §4

The downstream installations which are included in this standard are classified in accordance with the UNI 9165, as follows:

- 4th category gas pipeline with maximum working pressure higher than 0.15 and lower than 0.5 MPa.
- 5th category gas pipeline with maximum working pressure higher than 0.05 and lower than 0.15 MPa.
- 6th category gas pipeline with maximum working pressure higher than 0.004 and lower than 0.05 MPa, for gasses belonging to the first and second family.
- 7th category gas pipeline with working pressure not exceeding 0.004 MPa, for gasses belonging to the first and second family; gas pipeline with maximum working pressure not exceeding 0,007 MPa, for gasses belonging to the third family.

A plant may be constituted by different pressure track; the transition point among different pressure tracks must be constituted by a suitable pressure regulation group.

4.A ~ Italy

Picture 7: Installation of above and underground small tanks. Example of a regulation group with regulating first and second stages connected near the tank, with overpressure valves (A1 + A2) at the second stage.

Legend:

- 1 - Tank (above ground or underground)
- 2 - Tank's service valve
- 3 - First stage pressure regulator
- 4 - Fitting connection (PN16) between the first and the second stage regulators
- 5 - Second stage regulator with OPSO (A2) safety valve and pressure relief valve, PRV (A1)
- 6 - Dielectric coupling (if the underground gas pipeline is metallic)
- 7 - Shut-off valve
- 8 - Gas Pipeline (UNI 9860 – 5th category)
- 9 - Counter (optional)
- 10 - Indoor installation (UNI 7129)

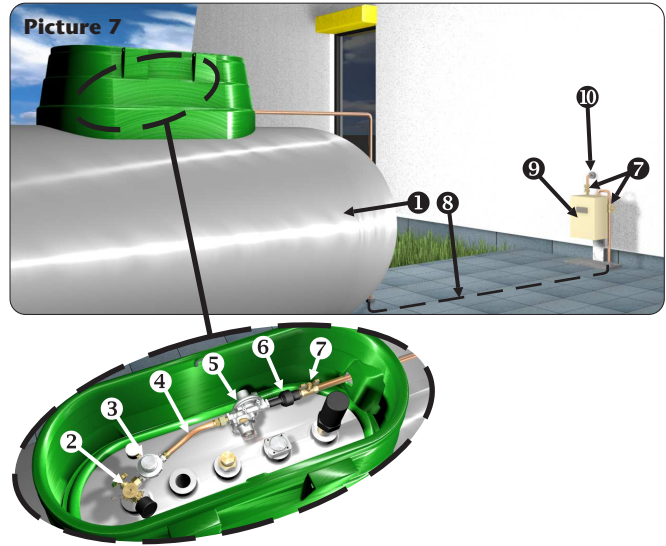

Picture 8: Installation of a small tank above ground or underground. Example of control unit composed of two separate stages, first and second, with limiter (A5) in the first stage and overpressure valves (A1 + A2) in the second stage.

Legend:

- 1 - Tank (above ground or underground)
- 2 - Tank's service valve
- 3 - First stage pressure regulator
- 4 - Fitting connection (PN16)
- 5 - Pressure limiter
- 6 - Junction pipe (UNI 9034) (optional)
- 7 - Dielectric coupling (if the underground gas pipeline is metallic)
- 8 - Shut-off valve
- 9 - Gas Pipeline (UNI 9860 – 5th species)
- 10 - Second stage regulator with safety valve OPSO (A2) and PRV (A1)
- 11 - Counter (optional)
- 12 - Indoor installation (UNI 7129)

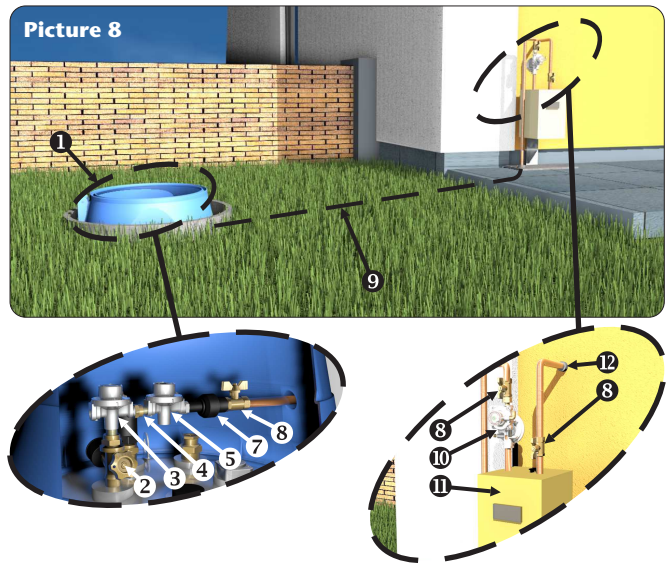

Picture 9: Installation of a small tank on the ground or underground. Example of first and second stage separate control unit, with OPSO (A2) safety device in the first stage control unit and overpressure valves (A1 + A2) in the second stage.

Legend:

- 1 - Tank (Underground or on the ground)
- 2 - Tank's service valve
- 3 - First stage regulator with safety valve OPSO (A2)
- 4 - Possible junction pipe (UNI 9034)
- 5 - Dielectric coupling (if the underground gas pipeline is metallic)
- 6 - Shut-off valve
- 7 - Gas Pipeline (UNI 9860 – 5th species)
- 8 - Second stage regulator with safety valve OPSO and PRV
- 9 - Counter (optional)
- 10 - Indoor installation (UNI 7129)

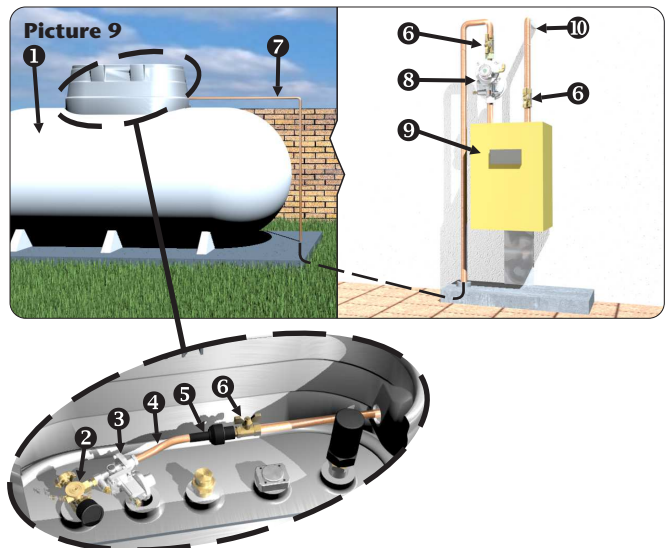

4.B ~ France

Domestic installation supplied with underground or above ground tanks

Domestic installation supplied with PROPANE from an underground or an above ground tank shall be composed from the following elements:

- First stage regulator
- Pressure limiter
- ON-OFF 2nd Stage Fixed Regulator with UPSO safety device
- Ball valves

The first stage regulator is usually connected directly to the tank valve and shall have an outlet pressure of 1.5 bar.

The pressure limiter is installed to protect the high pressure side of the installation and it is directly connected to the first stage regulator. This component shall be set at 1.8 bar.

The *Détenteur déclencheur* (this is how it is usually called the ON-OFF 2nd stage Fixed Regulator with UPSO safety device in France) is installed before each application and it is set at 37mbar.

If the tank is installed at a distance greater than 20m from the house, the installation shall be equipped with a ball valve, located outside the house. If this length is less than 20 m the installation a ball valve is recommended. Moreover, if the tank is underground a ball valve outside the house is strictly recommended.

The installation and the maintenance shall only be performed by qualified personnel.

Final user shall not attempt to try to modify the outlet pressure in any way.

For a permanent use outside the house, install the regulator in a position protected from the weather, paying great attention to the position of the vent hole.

CAUTION: Cavagna components of the installation are NOT designed for underwater use, whether immersed or semi-immersed, and MUST NEVER be surrounded by water, earth or stones. Never install it in places exposed to the risk of water flooding. IF THE REGULATOR IS INSTALLED IN OR IN THE VICINITY OF AN UNDERGROUND TANK SUMP, THE INSTALLER MUST ENSURE THAT IT IS ALWAYS PROTECTED FROM FLOODING, WEATHER AND DIRECT SUNLIGHT. In the event of flooding, the regulator must be replaced.

For a correct design of the installation, DTU n° 61-1 must be respected.

Outside the house

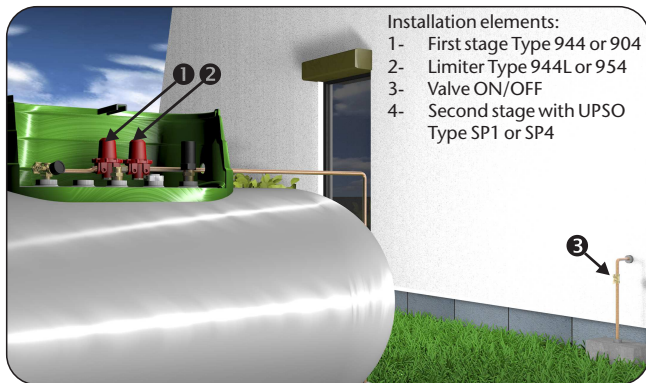

Inside the house



Installation elements:

- A General valve
- B First stage Type 944 or 904
- C Limiter Type 944L or 954
- D Valve ON/OFF
- E Second stage with UPSO Type SP4 (4 kg/h)
- F Second stage with UPSO Type SP1 (1 kg/h)

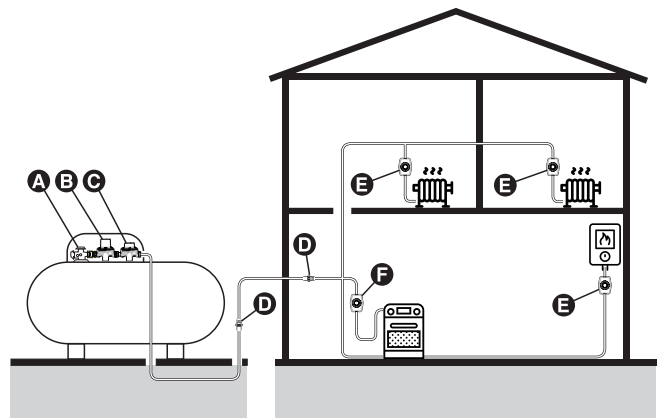

4.C ~ UK

Domestic installation supplied with underground or above ground tanks

Pipework safety and safety valves

The following elements are installed between the storage tank and the intake point at the building in order to control the pressure and to provide an emergency cut-off point:

- first-stage regulator, normally fitted to the vapour connection on the storage tank; reduces the pressure to about 0.75 bar; may also incorporate an overpressure shut-off (OPSO). Vent holes in regulators should be carefully oriented or otherwise protected against the possible ingress of water or substances which could cause blockage, and also to allow for drainage.

- second-stage regulator, fitted after the first-stage regulator, either at the tank or on the wall of the building; reduces the medium pressure of 0.75 bar to the working pressure of 37 mbar.

Bulk tank installations should incorporate an under pressure shut-off device (UPSO) which will operate if the gas supply pressure falls to a dangerously low level, e.g. because the storage vessel has become empty.

Bulk tank installations should also incorporate an over pressure shut-off device (OPSO) which will operate if the gas supply pressure rises to a dangerously high level, e.g. because the low pressure regulator has failed.

- emergency-control shut off.

First stage:

Type 904 - 1,5 bar plus OPSO (optional)

Type 944 - 1,5 bar plus OPSO (optional)

Second stage:

Type 781 - 37 mbar - PRV 75 mbar - OPSO 100 mbar - UPSO 27 mbar

Type 474/478 - 37 mbar - PRV 75 mbar - OPSO 100 mbar - UPSO 27 mbar

Twin stage:

Type 782 P.O.L. - 37 mbar - PRV 75 mbar - OPSO 100 mbar - UPSO 27 mbar

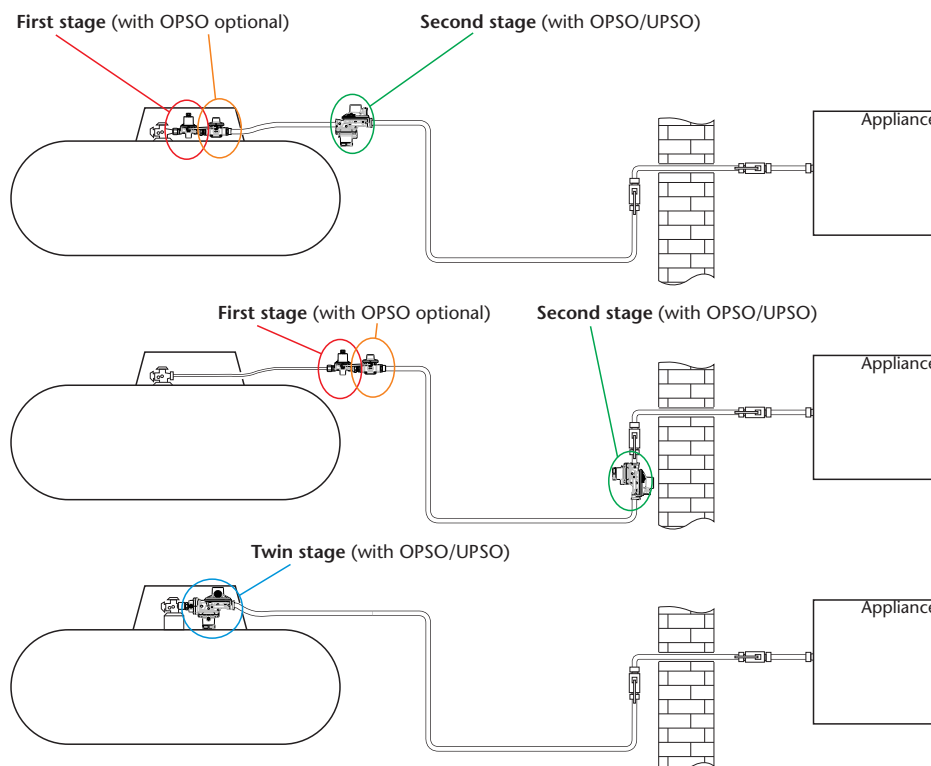

4.D ~ Belgium

Domestic installation supplied with underground or above ground tanks - Extracts from NBN D51-006 : 2016

Two stages installation

New installations shall be composed:

- Pre-regulation stage (first stage regulator + limiter) + second stage regulator
- Twin stage regulator (combination of first and second stage regulator) equipped with OPSO and UPSO security devices

Characteristics of the different types of regulators

Overview

All the regulators shall be designed to guarantee a gas flow equal at least at 1.2 times of the flow required from the appliances. Inlets and outlets of the regulators shall be designed with the following threads:

- Internal female threads in conformity with NBN EN 10226-1 standard;
- External male threads in conformity with NBN EN 10226-1 or ISO 68-1 (thread M 20 x 1,5) standard.

Regulators must always be placed outside the buildings.

First stage regulator

The first stage regulator shall be designed according with the following:

- It shall be installed directly on the tank valve or at the shortest distance;
- The maximum outlet pressure is 1,5 bar. This maximum pressure could be up to 5bar for non residential installation;
- It can be fixed or adjustable. If adjustable a manometer is required;
- It must always be placed outside the building.

Pressure limiter

The limiter device shall be designed according with the following:

- It must be directly connected to the first stage regulator;
- During normal functioning condition, the inlet pressure is equal to the first stage outlet pressure. Anyway the maximum admissible working pressure shall be at least equal to the maximum outlet tank pressure;

Second stage regulator

The second stage regulator shall be designed according with the following:

- It shall be installed downstream a first stage regulator;
- The outlet pressure must be equal to the nominal pressure required from the appliance or the appliances as indicated from the manufacturer (37 or 50 mbar);
- The regulator must be fixed for a flow 4 kg/h; for flow > 4 kg/h it could be fixed or adjustable (sealed after regulation); the adjustable regulator must be equipped with a manometer;
- A shut off valve shall always be installed upstream the second stage regulator;
- The second stage regulator and the shut off valve shall be installed in a protection box or a similar protection. It can also be installed under the protection cover of the tank. In this case the tank valve can be considered as the shut off valve.

Twin stage regulator with OPSO-UPSO

This regulator shall be in conformity with EN16129 and it's composed by :

- A first stage regulator equipped with an OPSO security;
- A second stage regulator integrated with the first stage equipped with an UPSO safety device;
- Safety devices shall be re-set manually;
- Upstream each applications, a shut off valve shall be installed;
- The admissible pressure lost between the exit of the twin regulator with OPSO-UPSO shall be 1mbar maximum.

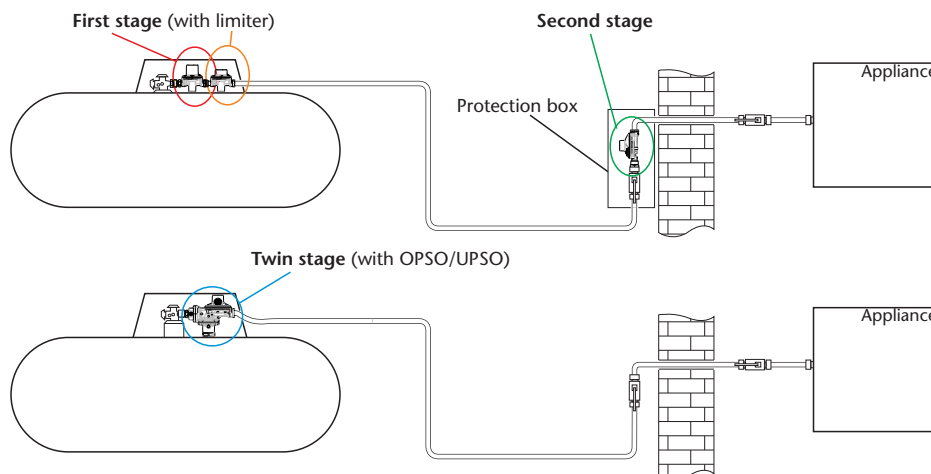



CAVAGNA group

Wherever gas is used, we are there

Our Global Product Brands

reca[®]

Kosan⁺**LINE**[®]

O.A.R.A.[®]

Kosangas[®]

omeca[®]

n.p.[®]

bigas[®]
A Cavagna Group Partner Company

cemco kosangas[®]

MESURA[®]
A Cavagna Group Company

MESURA[®]
METERING
A Cavagna Group Company

greengear[®]
looking ahead
A Cavagna Group Company

VIPROXY[®]

The Cavagna Group logo is a registered trademark of Cavagna Group SPA. All other marks are the property of their respective owners. RECA, KOSAN +, KOSANGAS, CEMCO KOSANGAS, O.A.R.A., OMECA, N.P., BIGAS, MESURA, MESURA METERING, GREENGEAR and VIPROXY are marks of the CavagnaGroup®.



CAVAGNA group

Wherever gas is used, we are there

Manufacturing Facilities

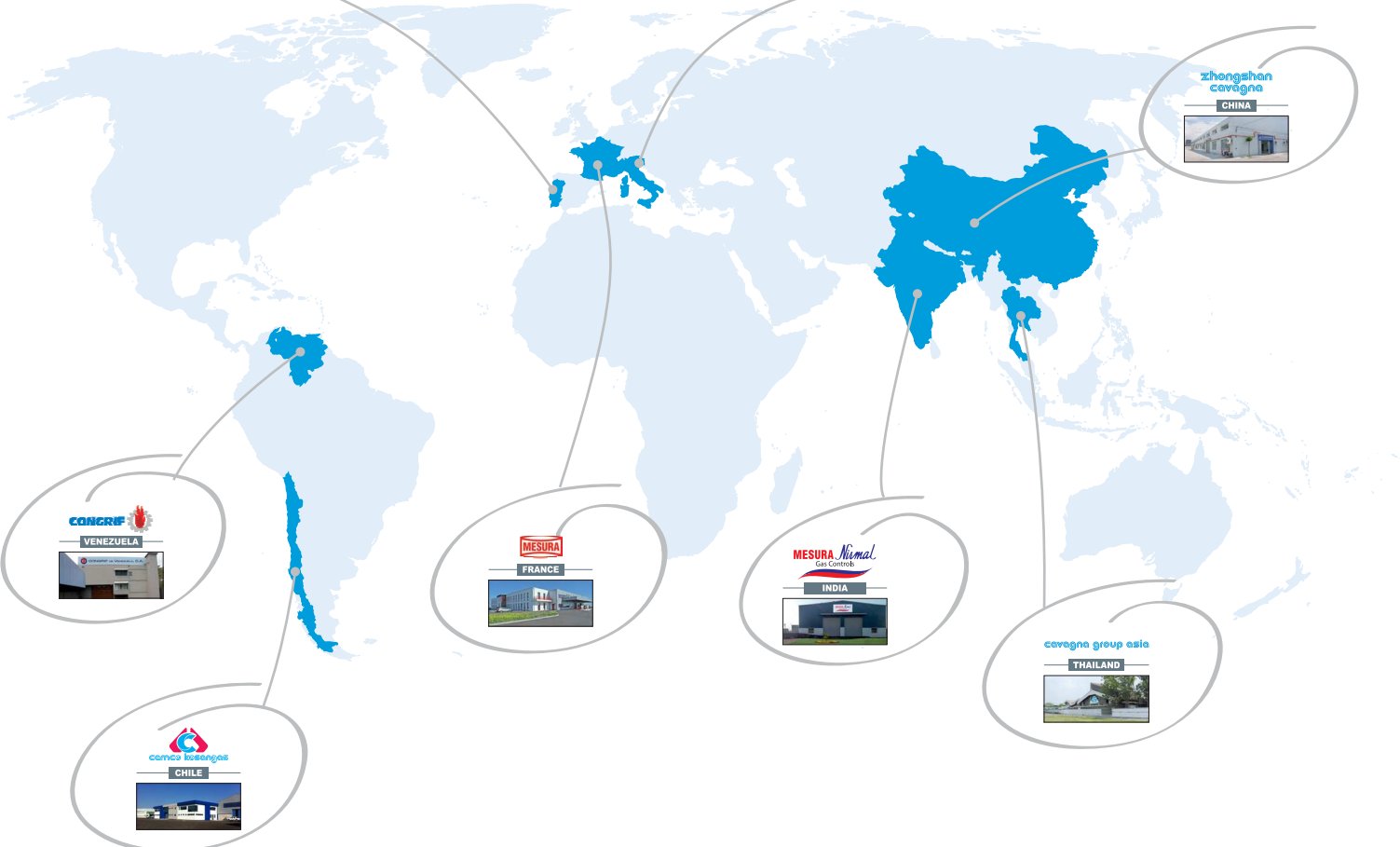



cavagna group

Wherever gas is used, we are there

Cavagna Group S.p.A. - Div. RECA
LPG & Natural Gas Regulators
Via Matteotti, 5 - 25012 Viadana di Calvisano (BS) - Italy
Tel +39 030 9688611 - Fax +39 030 9968712
www.cavagnagroup.com