

# MESURA *Nirmal*

Gas Controls

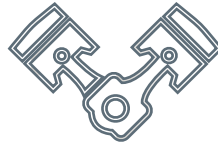

# Solutions



## LPG SOLUTIONS



## COMPRESSED GASES SOLUTIONS



## NATURAL GAS SOLUTIONS

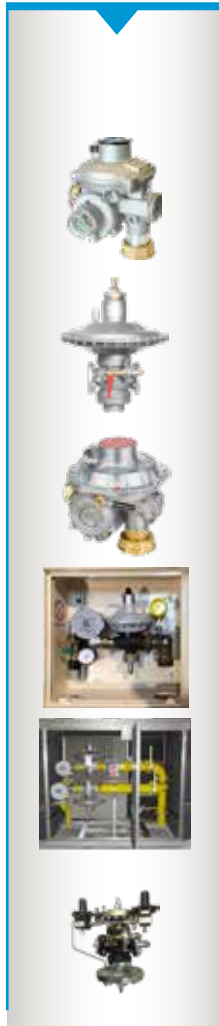

## ALTERNATIVE FUEL SYSTEMS



## GAS METERING SOLUTIONS



## OTHER





Gas Solutions

Mesura strengthened its international presence in Asia through a joint venture with Mesura Nirmal Industrial Control Ltd.

Mesura Sa. and Nirmal Industries has developed a successful partnerships, all based on trust, communication, integrity and success.



#### **About Mesura Nirmal Gas Control**

Mesura Nirmal specializes in offering solutions for the entire gas chain, including design, development, manufacture, installation & commissioning of pre-fabricated Skids for natural gas transmission and distribution applications, Filter Separators, Scrubbers, Knockout Drums, High pressure regulators, Safety shutoff valves.





## INDEX

---

<b>Examples of Application</b>	p. 6
--------------------------------	------

---

<b>Gas Conditioning Skids</b>	p. 9
-------------------------------	------

---

<b>Gas Pressure Regulating &amp; Metering Skids</b>	p. 17
---	-------

---

<b>Pilot-operated Gas Pressure Regulators</b>	p. 21
---	-------

---

<b>Slam Shut-Off Valves</b>	p. 27
-----------------------------	-------

---

<b>Direct Acting Regulators</b>	p. 31
---------------------------------	-------

---

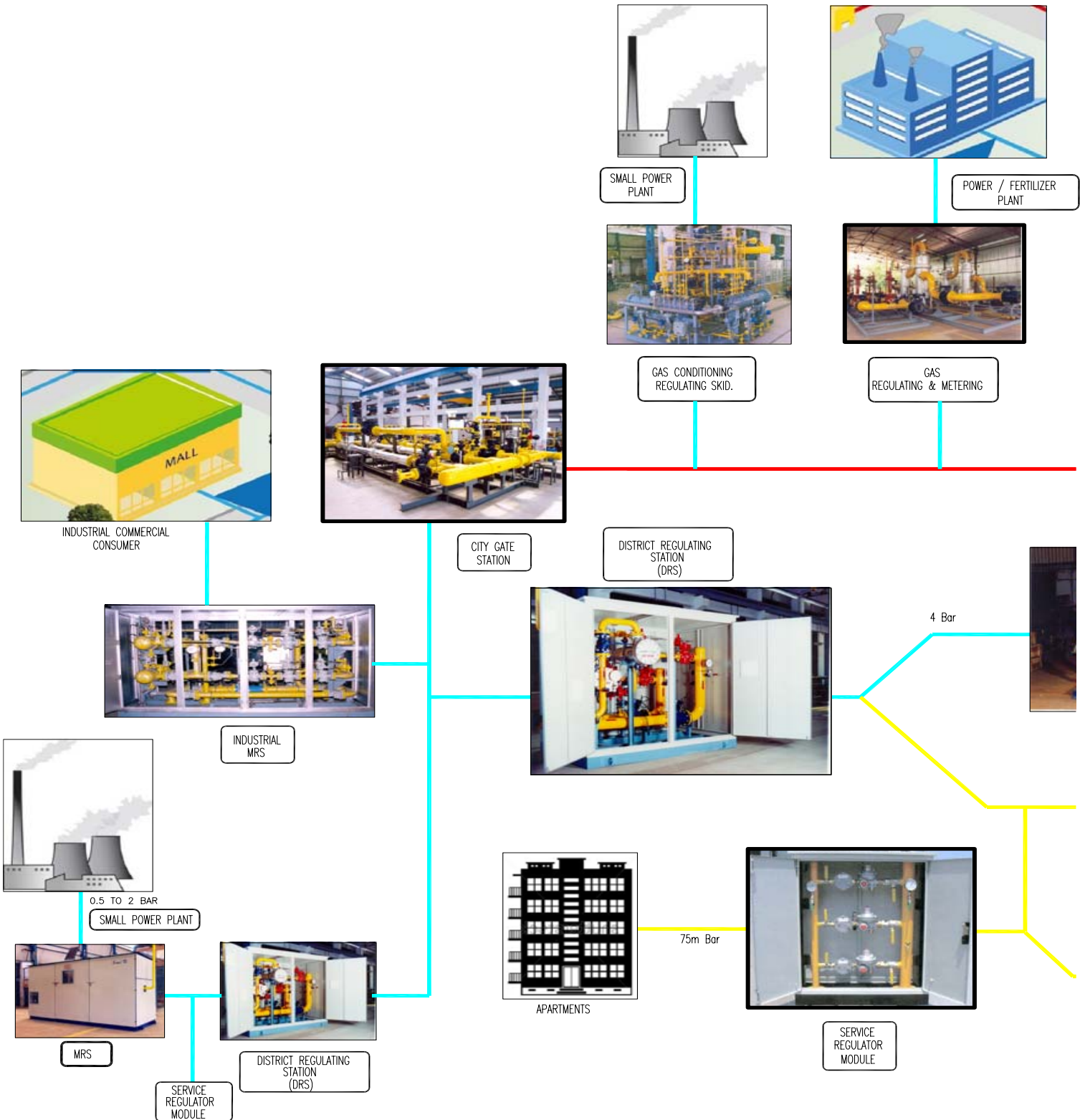

# GAS TRANSMISSION & DISTRIBUTION NETWORK

## LEGEND

- High Pressure Transmission Line —
- Medium Pressure Distribution Line —
- Low Pressure Distribution Line —

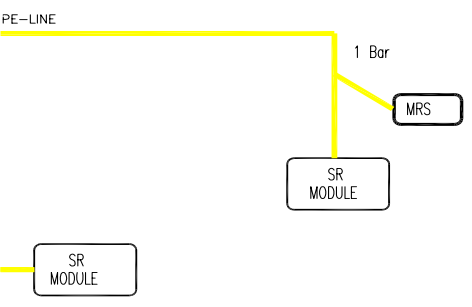
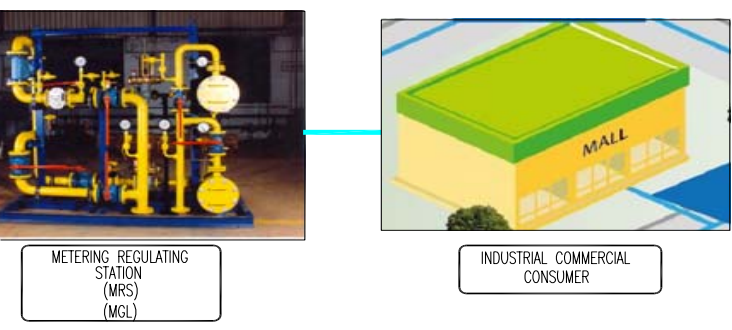
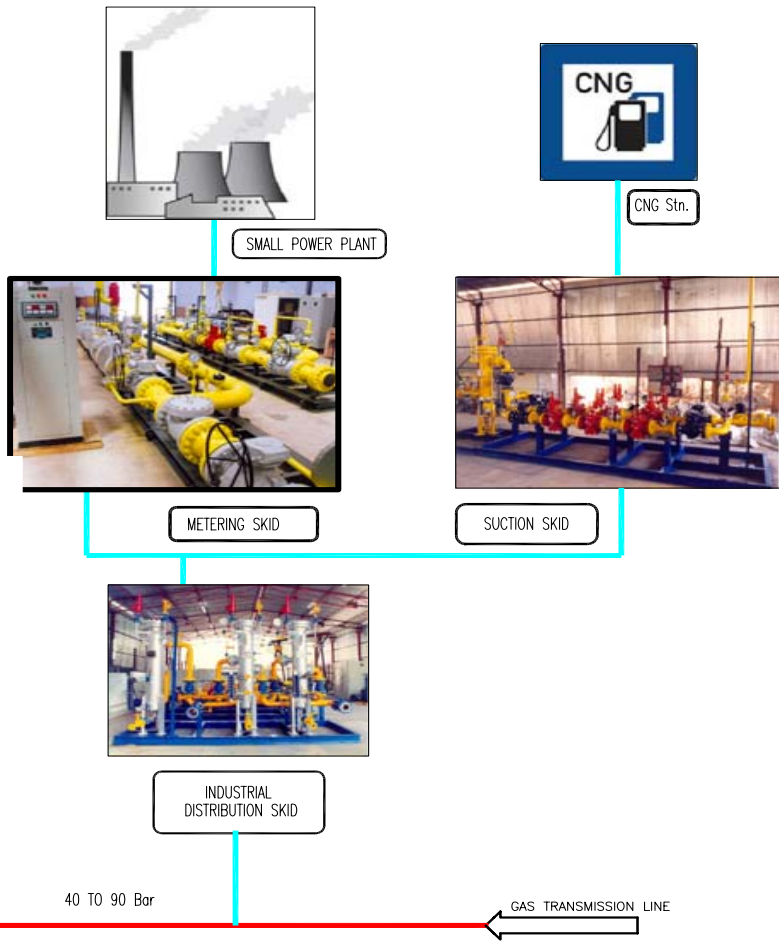

**MESURA** *Nirmal*  
Gas Controls

A decorative graphic element consisting of two overlapping, wavy, horizontal lines. The top line is blue and the bottom line is red, both tapering at the ends.





# Gas Conditioning Skids

## Gas Conditioning Skids

### Natural Gas Conditioning Skids

NIRMAL has rich experience of supplying complete package of Natural Gas conditioning skids consisting of emergency shut down, Primary Scrubbers, Filtration, Metering, Preheating, Pressure Reduction, Final Filtration, coalescing and liquid separation, Drain Tank, Vent Stack along with control panel, Gas Chromatograph, Leak Detectors, Remote Monitoring & Control through SCADA & other necessary instruments & equipments required for safe operation of Power Plant. Nirmal has Expertise in Filtration & Gas Heating which helps ensuring effective performance of the Gas Turbine/Gas Engine etc.



#### NATURAL GAS FILTRATION

NIRMAL is fully equipped to cater the requirement of Filtration systems which includes Knock Out Drum, Filter Separator/ Coalescers & Dry Gas Filters of various size & rating to cater the requirement in Fuel Gas Conditioning Skid used for the Power Plants/ City Gas Distribution Company.

#### APPLICATION FOR NATURAL GAS FILTRATION

Some of the contaminants that are introduced into the Natural Gas supply as a result of the production and transportation processes are:

- Water and salt water
- Sand and Clay
- Rust, iron sulfate, iron and copper sulfide
- Lubricating oil, wet scrubber oil, crude oil and hydrocarbon liquids
- Calcium carbonate
- Gas hydrates and ice
- Construction debris

#### RANGE OF SPECIFICATIONS & FEATURES:

**Maximum Working Pressure:** Up to 100 Barg\*

**Maximum Working Temperature:** Up to 60°C\*

**Pressure Rating:** Up to ANSI 600#

**Filtration:** Efficiency up to 0.3 microns can be achieved using special type of elements.

**End Connection:** As per ANSI B16.5

**Connection Size:** 1 "NB to 24" NB (Higher Size Available on Request)

**Shell Closure:** Quick Opening or Bolted Closure

**Installation Configuration:** Vertical or Horizontal

*\*Contact Nirmal for High Pressure & Temperature beyond above standard range.*

# Gas Conditioning Skids

## EK SERIES KNOCK-OUT DRUM / SCRUBBER / LIQUID SEPERATOR:

**Type:**

1. Demister Pad
2. Vane Pack
3. Multi-cyclone

Scrubber or Knock out Drum (KOD) is used to remove solid & liquid particles. Two main applications of Scrubber are at well-head & at compressor skid inlet. Other than these two, scrubber is used in many other industrial applications. It gives high efficiency even at varying pressure & flow conditions. These are low maintenance equipments.

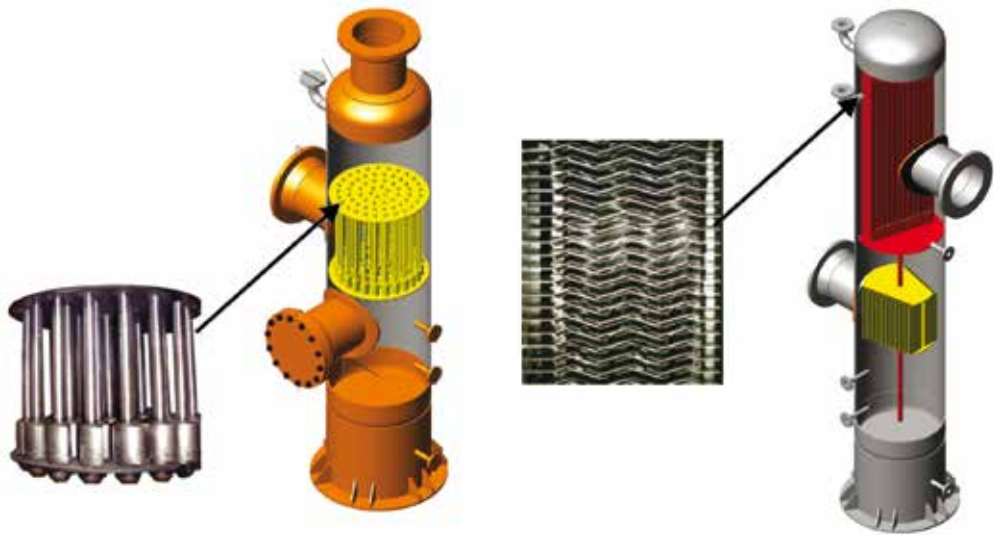

Multi Cyclone Type Scrubber

Vane Pack Type Scrubber

### PRINCIPLE OF OPERATION:

Scrubber consists of tube bundles assembled with multiple small diameter cyclone tubes. Gas enters through the tubes causing a circular motion of tube bundles, which in turn throw solid & liquid particles against wall of cyclone tubes. Clean gas rises out through the tubes. Impurities being heavier fall down & collected in drain area. Filtration efficiency up to 8 microns for solid as well as liquid can be achieved.

### EK SERIES KNOCK-OUT DRUM / SCRUBBER / LIQUID SEPERATOR MODEL CONFIGURATION

**EKV - A - EE - 1 - A - C - B - 1 - X - D - X**

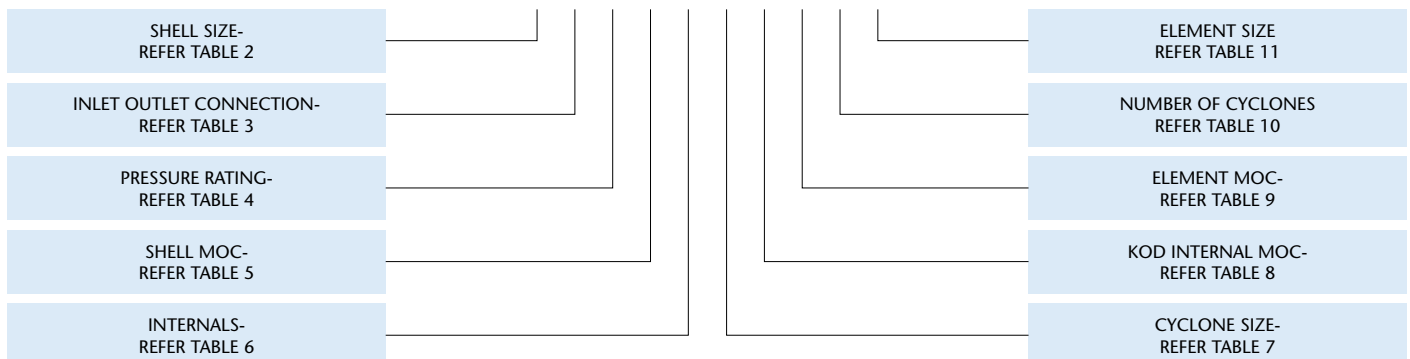

# Gas Conditioning Skids

## ES Series Filter Separator

Filter Separators are used to eliminate very fine dust or liquid particles. This is used where application demands for high efficiency. These are also used to remove oil traces if any from the Gas flow.

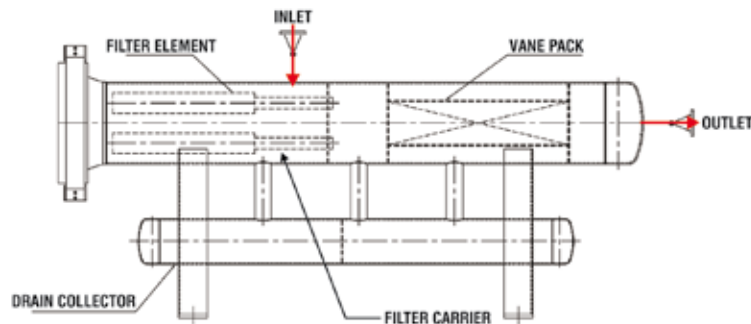

### PRINCIPLE OF OPERATION:

In filter separators solid particles are removed in 1st stage & liquid particles are removed in 2nd stage. Primarily larger solid particles are removed by gravity, since the velocity of incoming gas decreases. In 1st stage of filtration, smaller size solid particles are removed by means of filter elements. Then gas enters the vane pack arrangement i.e. 2nd stage filtration where liquid particles are removed. The contaminants generally are collected in a separate Storage vessel which remains connected to the filter separator. Filtration efficiency up to 3 microns for solid & liquid particles can be achieved and for special applications, filtration up to 0.3 microns can be achieved with special type of elements.

### ES SERIES FILTER SEPARATOR/WET GAS FILTER MODEL CONFIGURATION

**ES - V - A - EE-1 - A - V - X - 1 - X - X - X**

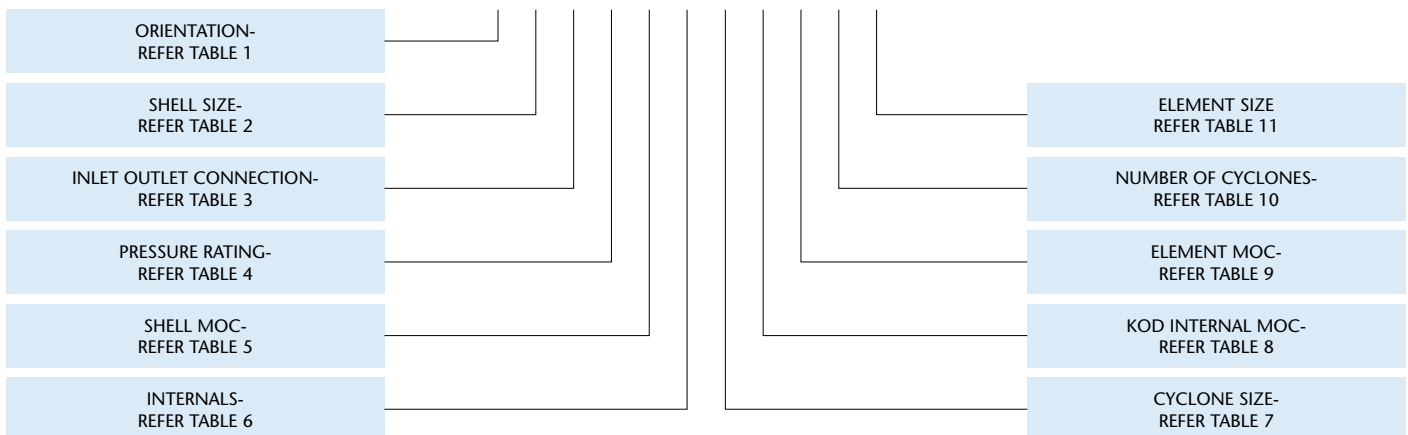

# Gas Conditioning Skids

## EF Series Dry Gas Filter

Dry Gas Filters are used to remove very small solid particles. Dry Gas filters remove the solid particles from Gas at any working condition, by designing the suitable filter elements. Decision of suitable no. of elements & elements with suitable filtration efficiency depend on various factors such as client's requirement of filtration efficiency grade, pressure drop, quantity of solid particles etc.

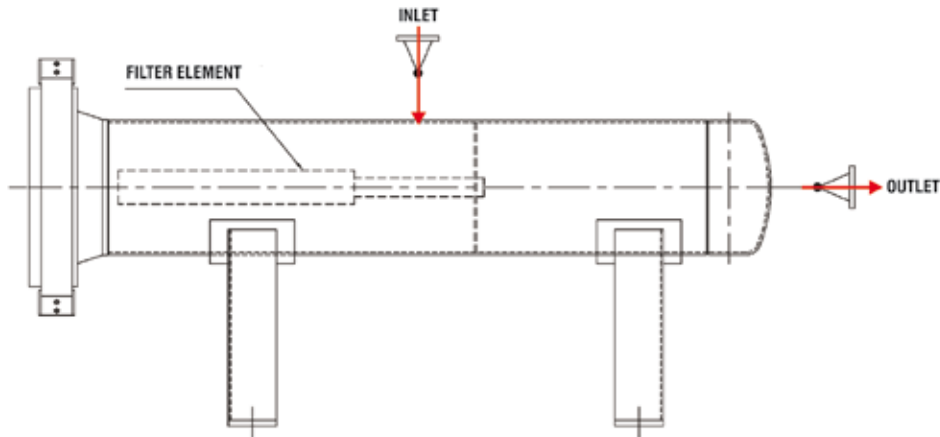

### PRINCIPLE OF OPERATION:

As Natural Gas gets into the filter its velocity decreases & heavy particles drop out of the main stream. Then gas flows through the fiber elements & solid particles are trapped in the fibers. Clean gas goes through the elements & to the filter outlet. Design of Cartridge Elements used is such that it causes coalescence effect. Free liquid in gas lay on the elements & form heavier liquid droplets. These get removed by gravity itself. Filtration efficiency up to 3 microns can be achieved.

### EF SERIES DRY GAS FILTER MODEL CONFIGURATION

**ES - V - A - EE-1 - A - V - X - 1 - X - X - X**

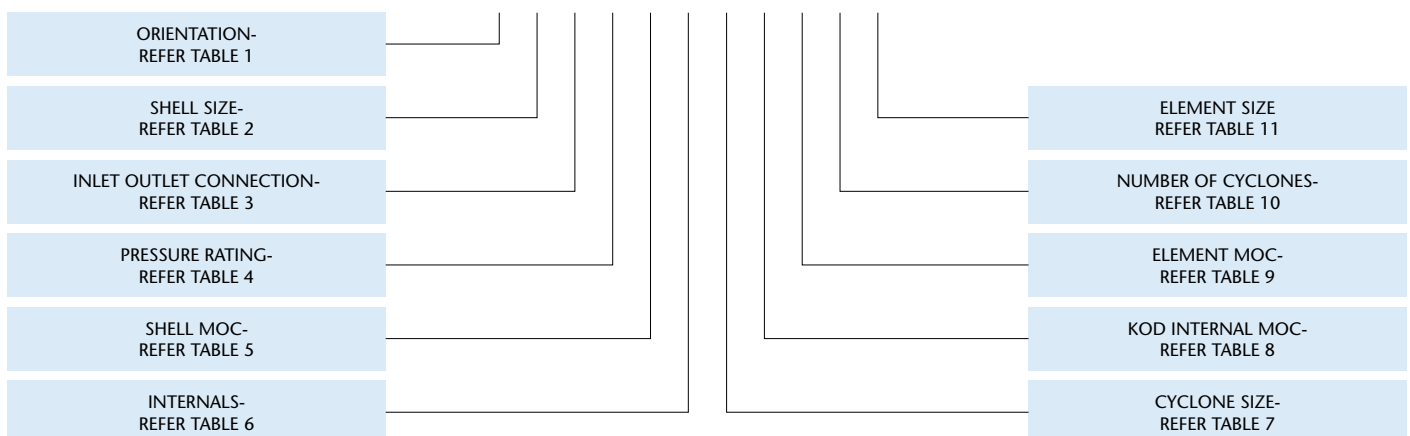

## Gas Conditioning Skids

### Tables

TABLE 1	
H	Horizontal
V	Vertical

TABLE 2	
A	4
B	6
C	8
D	10
E	12
F	14
G	16
H	18
I	20
J	24
O	Others

TABLE 3	
A	1/4
B	3/8
C	1/2
D	3/4
E	1
F	1 1/2
G	2
H	2 1/2
I	3
J	4
K	6
L	8
M	10
N	12
P	14
Q	16
R	18
S	20
T	24
O	Others

TABLE 4	
1	150
2	300
3	600
0	Others

TABLE 5	
A	A 106 Gr. B
B	A 516 Gr. 70
C	A 516 Gr. 60
D	A 515 Gr. 70
E	A 515 Gr. 60
F	A 312 TP 304
G	A 312 TP 316
H	A 240 Gr. 304
I	A 240 Gr. 316
O	Other

TABLE 6	
C	Cyclone
D	Damister Pad
B	Both
V	Vane Pack
O	Other
X	NA

TABLE 7	
A	1
B	2
C	3
D	4
E	5
F	6
G	7
H	8
I	9
J	10
K	11
L	12
M	13
N	14
O	15
P	16
Q	17
R	18
S	19
T	20
U	22
V	24
W	26
Y	28
Z	30
X	NA

TABLE 8	
1	CS
2	Ss304
3	Ss316
4	Ss410
0	Other
X	NA

TABLE 9	
B	Borosilicate Fiber Glass
P	Polypleted Synthetic Fiber
O	Other
X	NA

TABLE 10	
A	1
B	2
C	3
D	4
E	5
F	6
G	7
H	8
I	9
J	10
K	11
L	12
M	13
N	14
O	15
P	16
Q	17
R	18
S	19
T	20
U	22
V	24
W	26
Y	28
Z	30
X	NA

TABLE 11	
A	NG 75-40-200
B	NG 75-40-250
C	NG 75-40-300
D	NG 100-65-300
E	NG 100-65-400
F	NG 100-65-500
G	NG 145-106-300
H	NG 145-106-400
I	NG 145-106-500
J	NG 145-106-600
K	NG 95-54-984
L	NG 75-30-250
M	NG 75-30-500
N	NG 75-30-750
P	NG-3312
Q	NG-3324
R	NG-3336
S	NG-3536
T	NG-3738-45
U	NG-3738-3
V	NG-3738-10
W	NG-3738-30
X	NG-3738-50
Y	PN-14-338
O	Other
Z	NA

### Application For Natural Gas Heating

Heater is required to avoid the liquid condensate formation in the main line due to pressure reduction & surrounding temperature drop.

#### NEED FOR HEATER IS DICTATED BY FOLLOWING PARAMETERS

- Minimum temperature of gas supplied
- Temperature reduction due to Joule-Thomson effect in the PRS
- Hydrocarbon and Moisture Dew Point of the Gas
- Degree of superheat as recommended by Utility OEM like Gas Turbine, Gas Engine etc. (Temperature above Dew Point)

#### TYPE OF HEATERS USED IN NATURAL GAS APPLICATION

- Electric Heater
- Natural Gas fired Water Bath Heater
- Shell & Tube Steam HeatExchanges

## Gas Conditioning Skids

### EH series Gas Heater

#### EH/E Series - ELECTRIC HEATER

- > Used for lower capacity heaters up to 150KW.
- > Heating media used-electricity
- > Type of Control Panel **1.** On-Off **2.** Thyristor
- > Low Operation & Maintenance Cost

**PRINCIPLE OF OPERATION:** This is direct type of heating. It consists of high resistance Nickel-Chromium wire coated with Magnesium Oxide. These elements are covered with material having high temperature co-efficient like Stainless Steel. Natural gas is made to pass from the surface of these elements & gets heated. Necessary instruments are provided to protect the equipments from overheating & over pressure.

#### EH/F Series - FIRED INDIRECT WATER BATH HEATER

- > Used when capacity is higher than 150 KW
- > Heating Media-Natural Gas in the line
- > Type of Burner - **1.** Natural Draft **2.** Forced Draft
- > Type of Control - **1.** Pneumatic **2.** Electronic
- > Suitable for hazardous area with pneumatic control/ electronic control with ex-proof instruments

**PRINCIPLE OF OPERATION:** This is indirect type of heating. Natural Gas is taken from main line & is fed to burner at suitable pressure. The gas is burnt & water is heated. Coil is immersed in the water bath through which gas is passing. Gas temperature is controlled by controlling the gas fed to burner. Necessary instruments provided to ensure required water level & watertemperature inside the water bath, along with burner sequence controls and flame failure safety interlocks.

#### EH/S Series - SHELL & TUBE STEAM HEAT EXCHANGER

- > Low operating cost
- > Heating media-steam
- > Economical option where steam is easily available like fertilizer plant

**PRINCIPLE OF OPERATION:** This is direct type of heating. Steam is passed in shell side & Natural Gas is passed through tubes. Necessary Baffles are provided to increase heat transfer.

#### HEATERTYPE & CAPACITY DEPENDS ON FOLLOWING PARAMETERS:

- Mass flow of the gas to be heated
- Required temperature rise
- Gas composition
- Availability of heating media
- Hazardous area

#### EH SERIES HEATER MODEL CONFIGURATION

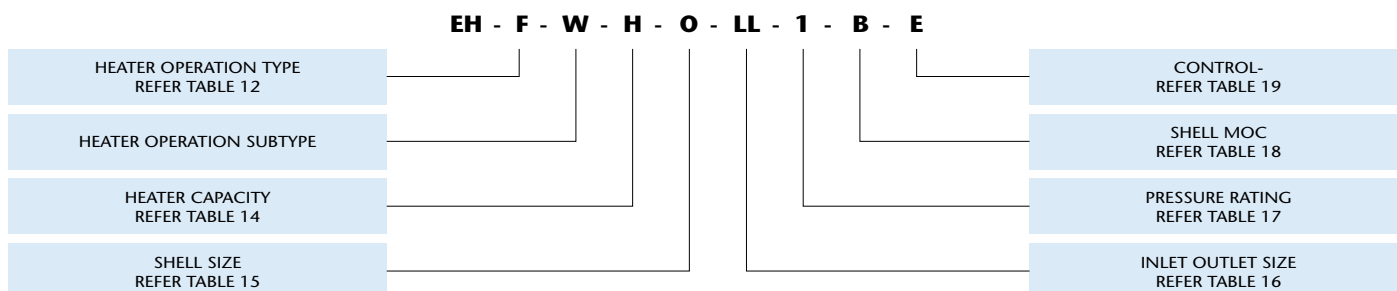

## Gas Conditioning Skids

### Tables

TABLE 12	
S	STEAM PERATED
E	ELECTRICAL OPERATED
F	GAS FIRED
C	CATALYTIC HEATER
O	OTHER
X	NA

TABLE 13	
W	WATER BATH
E	OIL BATH
T	TEMA (SHELL & TUBE TYPE)
O	OTHER
X	NA

TABLE 14	
A	5-20
B	21-40
C	41-60
D	61-80
E	81-100
F	101-150
G	151-200
H	201-300
I	301-500
J	501-700
K	701-1000
L	1001-1500
O	OTHERS
X	NA

TABLE 15	
A	4
B	6
C	8
D	10
E	12
F	14
G	16
H	18
I	20
J	24
O	OTHER

TABLE 16	
A	1/4"
B	3/8"
C	1/2"
D	3/4"
E	1"
F	1 1/2"
G	2"
H	2 1/2"
I	3"
J	4"
K	6"
L	8"
M	10"
N	12"
P	14"
Q	16"
R	18"
S	20"
T	24"
O	OTHERS

TABLE 17	
1	150
2	300
3	600
0	Other

TABLE 18	
A	A 106 Gr. B
B	A 516 Gr. 70
C	A 516 Gr. 60
D	A 515 Gr. 70
E	A 515 Gr. 60
O	OTHER

TABLE 19	
F	ON/OFF
P	PNEUMATIC
E	ELECTRICAL/ELECTRONICS
T	THYRISTOR
O	OTHER
X	NA





# Gas Pressure Regulating & Metering Skids

## Gas Pressure Regulating & Metering Skids

### SG Series Natural Gas Metering & Regulating Station

SG Series are the most popular Metering & Regulating Stations with very large number of installations operating for many years. SG MR Series & SG DR Series are complete packaged solutions ensuring highest level of security & reliability for supply of gas to commercial, industrial installations and City Gas Distribution Networks. SG MR Series Metering & Regulating Station caters to flows up to 2300 SCMH. SG DR Series Stations are widely used as District Regulating Stations / Common Pressure Regulating Stations in City Gas Networks for flows up to 11000 SCMH. The SG Series Stations lend itself to most sophisticated features of SCADA based remote monitoring & control functions.



#### SPECIFICATIONS & FEATURES

Station Design meets various requirements of international standards such as ANSI B-31.3 / 31.8; ASME Sec-VIII, Div-I; EN-12279; EN-12186; IGE-TD-13; AGA-7; AGA-5; AGA-8.

PED/97/23/EC compliance can be provided.

Twin Stream; Hot Stand-by; Active-Monitor Configuration offers multiple levels of security & redundancy ensuring trouble-free service for years together even at un-manned locations.

Over Pressure Safety Shut Off in case of abnormally high outlet pressure.

High Accuracy Outlet Pressure Control, irrespective of variation in inlet pressure & flow through the MRS/DRS.

RPD/Turbine Meter Options: Count on Nirmal expertise for the selection of metering techniques to suit particular requirement.

No External Power required:- With Solar Panel Powered Flow Computer/RTU Option of External power with battery back up also available.

#### OPTIONS

Smart Gas Remote Alarm Indications:

- a) Supply / Distribution Grid Pressure High / Low
- b) Door Lock Open
- c) SSV Trip Status
- d) Excess Flow consumption (for SG MR Series)
- e) High Filter differential Pressure

Smart Gas Remote Control Functions:- Emergency Gas Supply cut off; Outlet pressure set point adjustment; Flow Nomination & Flow Limiting.

Remote logging & configuration of all flow & process parameters using various telemetry options such as Telephone lines/ GSM /GPRS/Radio/Optic Fibre/V-SAT.

Flow Computer/RTU in place of EVC with more features. Power supply options of solar panel or external power with battery backup.

## Gas Pressure Regulating & Metering Skids

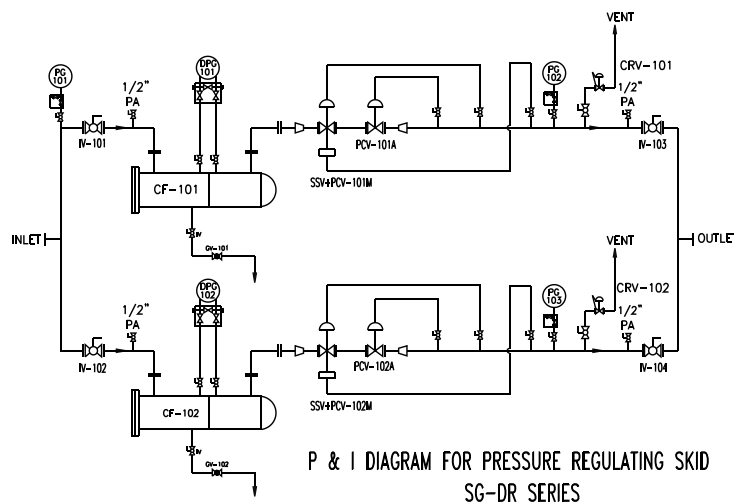

Figure - 1

### Specifications of SG DR Series Pressure Regulating Stations

P & I Diagram: Refer Figure - 1

End Connections: Flanged, SG-DR-204: Inlet-2" x Outlet-4" & SG-DR-306: Inlet-3" x Outlet-6", ANSI-B16.5; Rating 300# class and 150#

Filtration:- 5 Micron

Inlet Pressure:- 6 to 45 Kg/Cm2g

Outlet Pressure:- 2 to 4 Kg/Cm2g (Adjustable) Higher Outlet Pressures available with alternate spring ranges.

Flow Capacity:- Refer Table - 1 & 2

Regulation:- Pilot Operated Monitor Regulator with integral slam shut valve and Pilot Operated Active Regulator with pressure control accuracy to RG 2.5; Regulator & Slam Shut Comply to EN 334 & EN 14382.

Contact Nirmal for higher sizes, pressures, flows and any other specific requirements.

Table 1

FLOW CAPACITIES FOR SG-DR-204 PRESSURE REGULATING STATION									
SKID SIZE: 2" X 4"									
Outlet Pressure Barg	Minimum inlet Pressure Barg								
	6	8	10	12	15	19	24	30	35 to 45
2	990	1270	1560	1840	2270	2840	3240	3240	3240
3	990	1270	1560	1840	2270	2840	3550	4300	4300
4	990	1270	1560	1840	2270	2840	3550	4400	5110

Table 2

FLOW CAPACITIES FOR SG-DR-306 PRESSURE REGULATING STATION									
SKID SIZE: 3" X 6"									
Outlet Pressure Barg	Minimum inlet Pressure Barg								
	6	8	10	12	15	19	24	30	35 to 45
2	2190	2810	3440	4060	5000	6250	7340	7350	7350
3	2190	2810	3440	4060	5000	6250	7810	9650	9775
4	2190	2810	3440	4060	5000	6250	7810	9690	11250

Above Tables indicate flow capacity of DRS in SCMh considering velocity limits as following:

Before Filtration: 20 m/s

After Filtration: 40 m/s

# Gas Pressure Regulating & Metering Skids

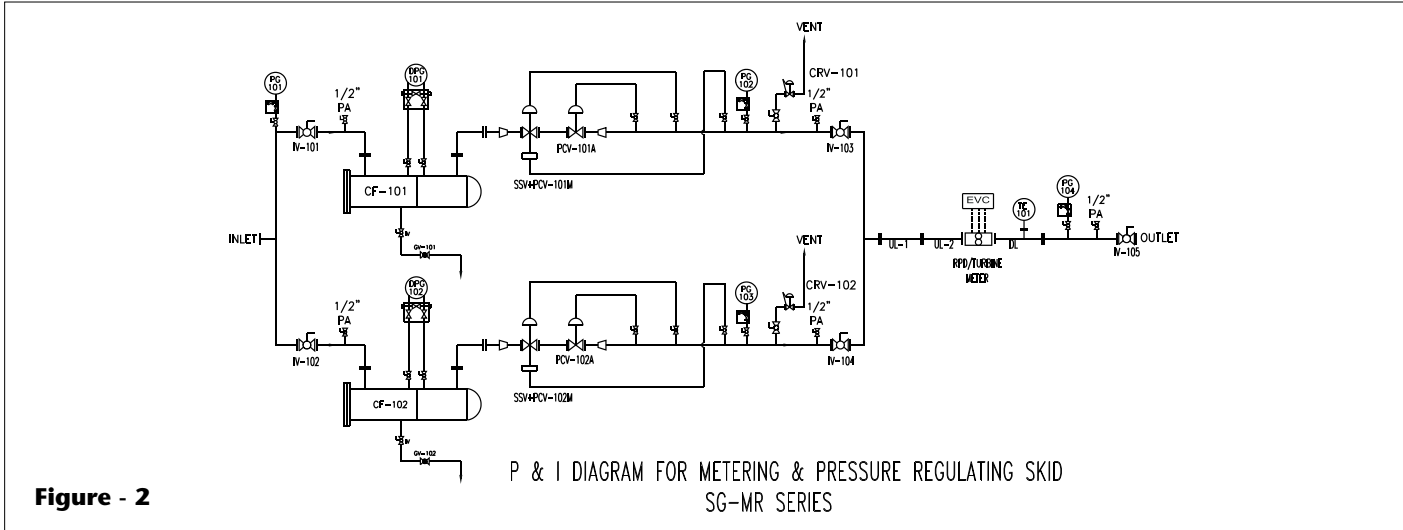

## Specifications of SG DR Series Pressure Regulating Stations

P & I Diagram:- Refer Figure - 1

End Connections:- Flanged, SG-DR-204: Inlet-2" x Outlet-4" & SG-DR-306: Inlet-3" x Outlet-6", ANSI-B16.5; Rating 300# class and 150#

Filtration:- 5 Micron

Inlet Pressure:- 6 to 45 Kg/Cm2g

Outlet Pressure:- 2 to 4 Kg/Cm2g (Adjustable) Higher Outlet Pressures available with alternate spring ranges.

Flow Capacity:- Refer Table - 1 & 2

Regulation:- Pilot Operated Monitor Regulator with integral slam shut valve and Pilot Operated Active Regulator with pressure control accuracy to RG 2.5; Regulator & Slam Shut Comply to EN 334 & EN 14382.

Contact Nirmal for higher sizes, pressures, flows and any other specific requirements.

**Table 3**

FLOW CAPACITIES FOR SG-MR METERING & REGULATING SKIDS					
Inlet Pressure (Kg/Cm2g)	2 to 16	2.5 to 16	3 to 16	3.5 to 16	4 to 16
Outlet Pressure (Kg/Cm2g)	1	1.5	2	2.5	3
Flow Scmh For 2" Size Skid Sg-Mr-202	180	225	270	315	360
Flow Scmh For 3" Size Skid Sg-Mr-303	450	560	675	785	900
Flow Scmh For 4" Size Skid Sg-Mr-404	1170	1460	1755	2045	2340

Nirmal is a market leader in the supply of Gas Measurement and Control Solutions.

Some of the gains of working in partnership with Nirmal are:

- Access to more than three decades of engineering solutions experience.
- Expert Knowledge of Transmission & Distribution application Engineering.
- Professional application engineers to assist you from Concept to Commissioning.
- Complete station manufactured in our own factory & fully tested in our computerized flow test lab.
- Designed & manufactured in compliance to ISO - 9001 - QA Systems.

Nirmal specializes in design, development, manufacture, installation & commissioning of pre-fabricated, skid mounted equipments for natural gas transmission and distribution applications, which include:

- Gas Scrubber, Filter & Conditioning skids.
- Gas Conditioning, Regulating & Metering Skids for Power Plants & Fertilizers.
- Gas Pre-Heaters.
- City Gate Stations.
- District Regulating Stations.
- Metering & Regulating Stations for Commercial & Industrial Installations.
- Gas Pressure Regulating Stations.
- Fiscal and Secondary Metering Skids.
- Safety and Control Systems.
- Design, Project Management and Build.



# Pilot-operated Gas Pressure Regulators

## Pilot-operated Gas Pressure Regulators



### D53 Series - Gas Pressure Regulator

The SERIES D53 regulators provide accurate pressure control in a variety of applications: natural gas transmission and distribution systems, fuel gas supply to power plants, industrial boilers, furnaces and mixers; and commercial or industrial business such as steel mills, asphalt plants, and shopping centers. This regulator is used with double stage pilot pressure loading. The superior performance of this regulator is due to the amplifying effect of the pilot and the two-path control system. Changes in outlet pressure act quickly on the actuator diaphragm to provide fast response to changes. The pilot amplifies system changes, positioning the main valve for precise control. These regulators can be provided with built-in Slam Shut Off device having over and under pressure shut off.

#### FEATURES

- **Tight Shut Off Capability:** Special trim design eliminates wear and erosion of seating, providing excellent tight shut off capability over long working life.
- **Active Monitor Configuration Suitability:** This model is suitable for use as Active Monitor Configuration.
- **Double Stage Pilot Control:** Because of double stage pilot design, these regulators can handle high variations in inlet pressure without affecting the accuracy of outlet controlled pressure.
- **Easy to Maintain:** Sturdy and compact design with minimum number of moving parts. Actuator internals, valve disc & trim parts can be replaced without removing the regulator from pipe line.
- **Local Position Indicator:** Position indicator is built-in feature for indicating trim movement. Optionally position transmitter can be mounted for position feedback at remote location.
- **Built-in Slam Shut Off Option Available:** Built-in Slam Shut Off (with OPSO & UPSO) can be provided as an optional feature. SSV can be provided with local position indicators & limit switches for remote feedback.

#### CERTIFICATIONS:

PED 97/23/EC compliance (CE marking);  
Ceri. no. CE-PED-H-NIC001-12-IND  
EN334 certification;  
Cert. no. CE-PED-B-NIC 001-07-IND &  
CE-PED-B-NIC 001-09-IND

### ACTIVE MONITOR CONFIGURATION

In this configuration, the monitor regulator is installed upstream of the main (active) regulator. Although their roles are different, the two regulators are virtually identical from the point of view of their mechanical construction. The only difference is that the monitor is set at a higher pressure than the main active regulator.

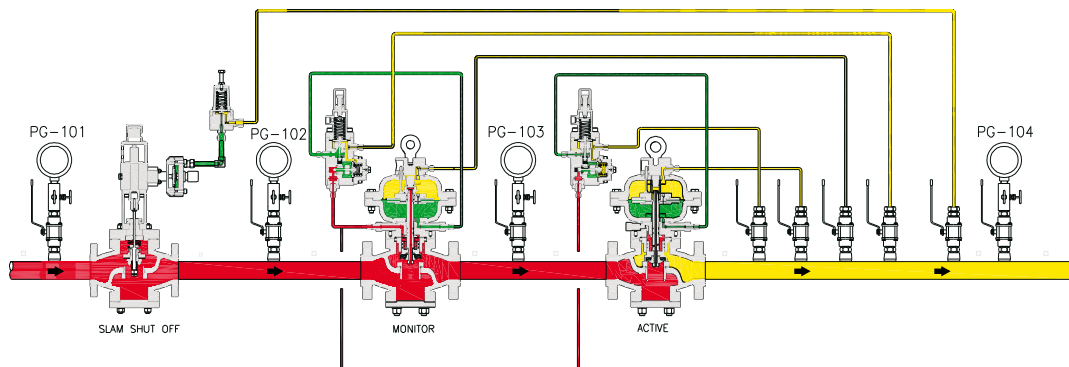

Normally, monitor remains Wide open and active regulator regulates the outlet pressure at the set value. If, in case of contingency, controlled pressure tends to rise, monitor regulator takes over and regulates the controlled pressure at its set value, which is marginally higher than that of active regulator.

## Pilot-operated Gas Pressure Regulators



### D53/S Series - Regulator With Built-In Slam Shut Device

SERIES D53 pressure regulator offers the possibility of installing an incorporated slam shut off device whenever it is functioning either as a main or as a monitor regulator. The incorporated slams shut off device can be retrofitted to SERIES D53 regulator without modifying the pressure reduction assembly. Thus, all the specifications are same as that of SERIES D53 regulator.

#### SLAM SHUT OFF

This device cuts off the gas flow if any failure causes the downstream pressure to rise and reach the set point of the slam shut itself. The slam shut off device can be re-set manually.

#### FEATURES

- Accuracy Group AG: up to 1 (according to EN14382).
- Tight Shut Off Capability: Special trim design eliminates wear and erosion of seating, providing excellent tight shut off capability over long working life.
- Easy to Maintain: Easy replacement of internal parts without dismantling the main regulator from line.
- Manual Re-setting: Manual re-setting with the lever mechanism.
- Built-in Pressure Equalization: On slight turning the reset lever, a small opening in valve equalizes inlet and outlet pressure. No separate by-pass or equalizing valve is required.
- Local Position Indication: Open/Close position indicator dial indicates slam shut device position.
- Remote Signal Devices Option: Slam shut off can be provided with remote signal devices (like contact switches or proximity switches).

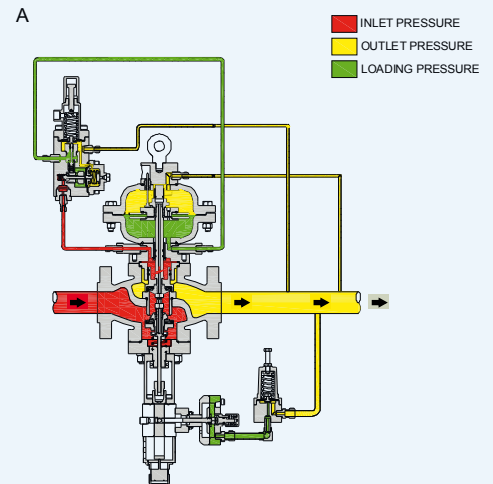

### SERIES D53 WITH IN-BUILT SAFETY SHUT OFF DEVICE INSTALLATION

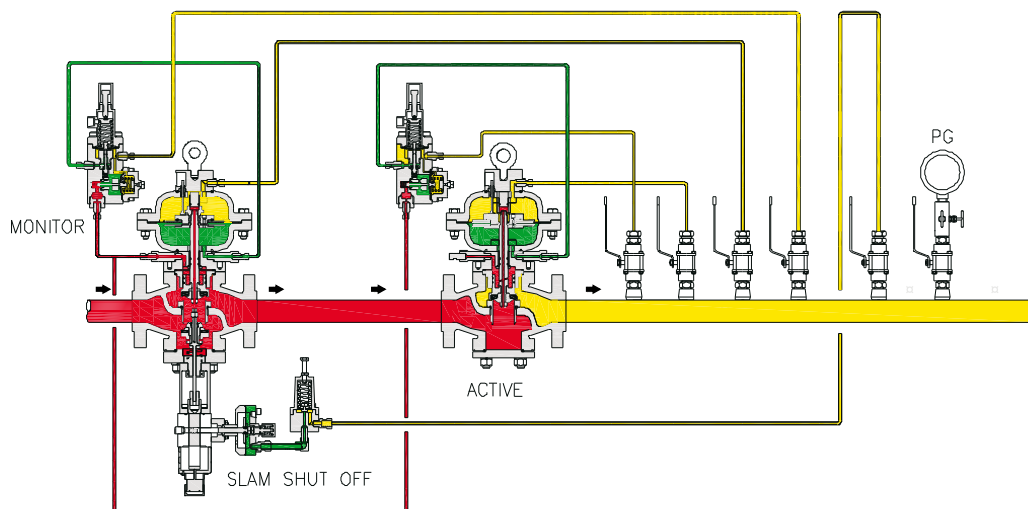

# Pilot-operated Gas Pressure Regulators

**Table 2: SERIES D53 Model Configurations**

	D53 /	S	E2	-	25	-	F1	/	0	E
<b>Function:</b>	D53/E	.... Standard Regulator								
	D53/S	.... Combined Slam Shut Off								
	D53/U	.... Combined OPSO & UPSO Slam Shut Off								
<b>Set Pressure Range:</b>										
	Regulator Set Pr.	Pilot Valve								
E1	.... 0.5 to 2.0 BarG	... NP1								
E2	.... 1.5 to 6.0 BarG	... NP1								
E3	.... 4.0 to 18.0 BarG	... NP1								
E4	.... 10.0 to 30.0 BarG	... NP1								
E5	.... 25.0 to 50.0 BarG	... NP9								
	Regulator Set Pr.	OPSO								
S1	.... 0.5 to 2.0 BarG	.... 1.0 to 5.0 BarG	.... NP5 (A)							
S2	.... 1.5 to 6.0 BarG	.... 1.0 to 5.0 BarG	.... NP5 (A)							
S3	.... 1.5 to 6.0 BarG	.... 5.0 to 10.0 BarG	.... NP5 (A)							
S4	.... 4.0 to 18.0 BarG	.... 6.0 to 15.0 BarG	.... NP5 (B)							
S5	.... 4.0 to 18.0 BarG	.... 10.0 to 25.0 BarG	.... NP5 (B)							
S6	.... 10.0 to 30.0 BarG	.... 10.0 to 25.0 BarG	.... NP5 (B)							
S7	.... 25.0 to 50.0 BarG	.... 24.0 to 55.0 BarG	.... NP3							
	Regulator Set Pr.	OPSO	UPSO							
U1	.... 0.5 to 2.0 BarG	.... 1.0 to 5.0 BarG	.... 0.5 to 2 BarG	.... NP6						
U2	.... 1.5 to 6.0 BarG	.... 1 to 5 BarG / 6 to 10 BarG	.... 0.5 to 2 BarG	.... NP6						
U3	.... 4.0 to 18.0 BarG	.... 6 to 15 BarG / 10 to 25 BarG	.... 4.0 to 10 BarG	.... NP6						
U4	.... 4.0 to 18.0 BarG	.... 6 to 15 BarG / 10 to 25 BarG	.... 4.0 to 10 BarG	.... NP6						
<b>Regulator Size:</b>										
	025	.... DN 25								
	050	.... DN 50								
	080	.... DN 80								
	100	.... DN 100								
	150	.... DN 150								
	200	.... DN 200								
<b>Flange Rating</b>										
F1	.... ANSI B16.5 150# (Max. differential Pressure 19 Bar) / PN 10/16/20									
F3	.... ANSI B16.5 300# (Max. differential Pressure 48 Bar) / PN 25/40/50									
F6	.... ANSI B16.5 600# (Max. differential Pressure 97 Bar) / PN 110									
<b>Other Special Features (if applicable) to be specified</b>										
E	.... Enhanced Cg Value									
R	.... Regular Cg Value									

**Table 3: Dimension & Weight of D53 Gas Pressure Regulator**

ANSI 150#								
SIZE	H (MAX)	B	ØD	L	p	d	n	Weight
1" (25NB)	550	90	108	184	79.4	16	4	35
2" (50NB)	600	125	152.2	254	120.6	19	4	47
3" (80NB)	675	160	190.4	298	152.4	19	4	68
4" (100NB)	750	192	228.6	352	190.5	19	8	105
6" (150NB)	850	235	279.4	451	241.3	22.2	8	155
8" (200NB)	970	280	342.9	543	298.5	22.2	8	190
ANSI 300#								
SIZE	H(MAX)	B	ØD	L	p	d	n	Weight
1" (25NB)	550	90	123.6	197	89	19	4	38
2" (50NB)	600	125	165	267	127	19	8	52
3" (80NB)	675	160	209.5	317	168.3	22.2	8	75
4" (100NB)	750	192	254	368	200.1	22.2	8	115
6" (150NB)	850	235	317.5	473	269.7	22.2	12	170
8" (200NB)	970	280	342.9	568	330.2	25	12	200
ANSI 600#								
SIZE	H(MAX)	B	ØD	L	Pp	d	n	Weight
1" (25NB)	550	90	124	210	88.9	19	4	48
2" (50NB)	600	125	165	286	127	19	8	62
3" (80NB)	675	160	209.5	337	168.1	22.2	8	88
4" (100NB)	750	192	273	394	215.9	25	8	130
6" (150NB)	850	235	355.6	508	292.1	28.5	12	185
8" (200NB)	970	280	342.9	610	349.2	28.5	16	215

All dimensions are in mm & Weight in Kg n = Number of Holes

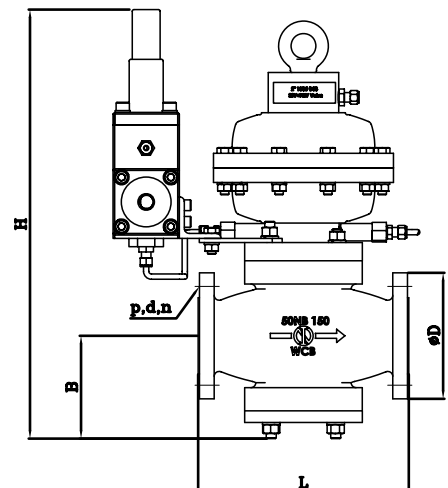



# Pilot-operated Gas Pressure Regulators

## SPECIFICATIONS

**Body Size & Connections:** Flanged: 1", 2", 3", 4", 6" & 8" ANSI B16.5 Class 150#, 300# & 600#

(Higher sizes & ratings on request)

**Model Configurations:** As per Table 2

**Accuracy Class AC:** up to 1.0 (according to EN-334)

**Lock-up pressure Zone class SZ:** upto 2.5

**Max. Inlet Pressure Pressure:** 20 Barg for Flanged ANSI B16.5, 150# rating, 50 Barg for Flanged ANSI B16.5, 300# rating & 100 Barg for Flanged ANSI B16.5, 600# rating

**Material of Construction:**

*Body\*:* A216 Gr. WCB (Standard 150#), A352 Gr. LCB (Standard 300#&600#), A351 CF8.A351 CF8M

*Diaphragm Casing\*:* Same as body MOC

*Internal Trim Parts\*:* SS316 (Standard), SS304,

SS316L, SS304L, Copper, Brass

\*NACE & other special material available on request

*Disc & Diaphragm:* Nitrile (Standard), Neoprene, EPDM, Silicone, PTFE, Fluoropolymer

*Temperature Capabilities:* -20°C to 60°C

(extended temperature ranges available on request)

*Pressure Setting Adjustment:* May be adjusted throughout a spring range by turning the adjusting screw of pilot.

*Pressure Registration:* External 3/8" NPTF

*External Dimensions & Weights:* Refer Table 3

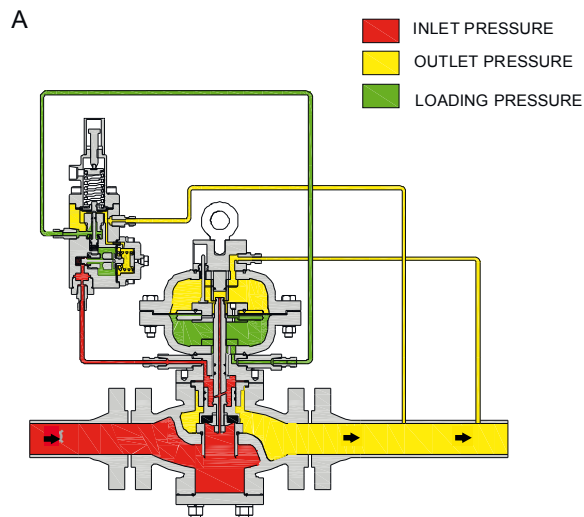

## CAPACITY / SIZING CALCULATIONS

To find out the regulating flow capacity, use equation;

For  $\Delta P < 0.5 P_u$  (sub-critical condition)

$$Q = \frac{13.57}{\sqrt{d(tu + 273)}} C_g \sqrt{Pd(P_u - Pd)}$$

For  $\Delta P > 0.5 P_u$  (critical condition)

$$Q = \frac{13.57}{\sqrt{d(tu + 273)}} C_g \frac{P_u}{2}$$

**Where;**

Q = Flow in Normal m<sup>3</sup>/Hr

P<sub>u</sub> = Inlet Pressure in Bar Abs.

P<sub>d</sub> = Regulator Set pressure in Bar Abs.

d = Specific Gravity of Gas w.r.t. air

tu = Temperature at the inlet in °C

C<sub>g</sub> = Flow Coefficient

AP = Differential Pressure (P<sub>u</sub> - P<sub>d</sub>)

**Table 1: Flow Coefficients**

Valve Size	1"	2"	3"	4"	6"	8"
Cg Value (Regular)	380	1500	3000	5000	10800	17200
Cg Value (Enhanced)	550	2220	4700	7800	14500	24000

# Pilot-operated Gas Pressure Regulators

**Table 4: Dimension & Weight of D53 Gas Pressure Regulator with Built-in Slam Shut Device**

ANSI 150#								
SIZE	H (MAX)	B	OD	L	P	d	n	Weight
1" (25NB)	1100	406	108	184	79.4	16	4	42
2" (50NB)	1200	435	152.2	254	120.6	19	4	54
3" (80NB)	1250	475	190.4	298	152.4	19	4	75
4" (100NB)	1350	502	228.6	352	190.5	19	8	115
6" (150NB)	1450	565	279.4	451	241.3	22.2	8	165
8" (200 NB)	1640	700	342.9	543	298.5	22.2	8	210

ANSI 300#								
SIZE	H (MAX)	B	OD	L	P	d	n	Weight
1" (25NB)	1100	406	123.6	197	89	19	4	45
2" (50NB)	1200	435	165	267	127	19	8	60
3" (80NB)	1250	475	209.5	317	168.3	22.2	8	82
4" (100NB)	1350	502	254	368	200.1	22.2	8	125
6" (150NB)	1450	565	317.5	473	269.7	22.2	12	180
8" (200 NB)	1640	700	381	568	330.2	25	12	220

ANSI 600#								
SIZE	H(MAX)	B	OD	L	P	d	n	Weight
1"(25NB)	1100	406	124	210	88.9	19	4	55
2" (50NB)	1200	435	165	286	127	19	8	70
3" (80NB)	1250	475	209.5	337	168.1	22.2	8	95
4" (100NB)	1350	502	273	394	215.9	25	8	140
6" (150NB)	1450	565	355.6	508	292.1	28.5	12	195
8" (200 NB)	1640	700	419.1	610	349.2	28.5	16	235

All dimensions are in mm & Weight in Kg      n = Number of Holes

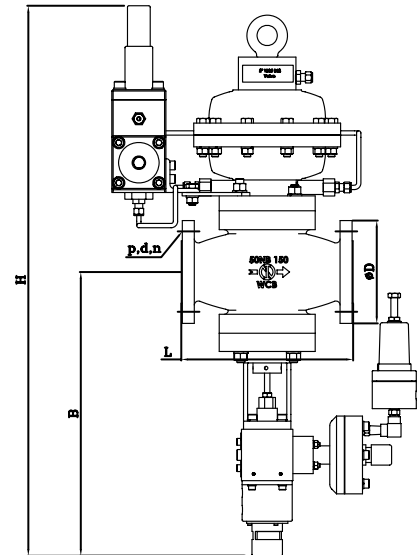



# Slam Shut-Off Valves

## Slam Shut-Off Valves



### SH4 Series - Safety Shut-Off Valves

SERIES SH4 safety shut off valve shuts off the gas flow when the pressure it is monitoring rises and reaches the set point of the slam shut valve due to any failure in the pressure regulating system. The slam shut off device has to be re-set manually.

These valves are for use in variety of applications: natural gas transmission & distribution systems, fuel gas supply to power plants, furnaces and mixers; and commercial or industrial businesses.

These valves can be also provided with under pressure shut-off feature.

#### FEATURES

- **Tight Shut Off Capability:**

Special trim design eliminates wear and erosion of seating, providing excellent tight shut off capability over long working life.

- **Easy to Maintain:**

Easy replacement of internal parts without dismantling the main valve body from line.

- **Manual re-setting:**

Manual re-setting with the lever mechanism.

- **Built in Pressure Equalisation:**

On slight turning the reset lever, a small opening in valve equalizes inlet and outlet pressure. No separate by-pass arrangement or equalizing valve is required.

- **Local position indication:**

Open/Close position indicator dial indicates slam shut device position.

- **Remote Signal devices option:**

Slam shut off can be provided with remote signal devices (like contact switches or proximity switches).

**CERTIFICATIONS:**

**PED 97/23/EC compliance (CE marking);**

Certificate no. CE-PED-H-NIC 001-12-IND

**EN 14382 certification;**

Certificate no. CE-PED-B-NIC 001-07-IND

& CE-PED-B-NIC 001-09-IND

#### CAPACITY CALCULATIONS

To determine the flow capacity of gases through the valve, use equation (a)

$$(A) \quad Q = \frac{13.57}{\sqrt{d(tu + 273)}} C_g \sqrt{Pd \times \Delta P}$$

To find out the pressure drop across the valve at known flow, use equation (b)

$$(B) \quad \Delta P = \left[ \frac{13.57}{13.57 \times C_g} \right]^2 \times \frac{d(tu + 273)}{Pd}$$

**Where;**

Q = Flow in Normal M<sup>3</sup>/Hr

Pd = Inlet Pressure in Bar Abs.

ΔP = Pressure drop in Bar

d = Specific Gravity of Gas w.r.t. air

tu = Temperature at the inlet in °C

Cg = Flow co-efficient of valve available in Table 1

**Table 1: Flow Coefficients**

Valve Size	1"	2"	3"	4"	6"
Cg Value (Regular)	430	1700	3400	5700	12200
Cg Value (Enhanced)	575	2350	4750	7850	15500

#### PRODUCT DESCRIPTION

The valve construction comprises of main valve body, control mechanism and sensing element.

The main valve body is connected in the main line which is to be safe guarded against over-pressurisation.

The control mechanism has latching arrangement that holds the main valve stem in open position.

The sensing element is pilot valve which continuously monitors the line pressure which is to be safeguarded. This pilot is spring diaphragm type valve and in case of over-pressurisation it gives signal to control mechanism which in turn trips off the main valve. The valve can be re-opened only by manual resetting. Before resetting the valve ensure that the cause of over-pressurisation is found and rectified.

#### RESETTING THE VALVE

To reset the valve to open position first the reset shaft is to be turned slightly. This opens the pressure equalizing orifice in the valve. Allow the pressure at inlet and outlet of the valve to equalise. Once the pressure is equalised reset lever can be swung easily to open position. Once the shaft reaches to full open position it is automatically latched in position. The position indicator will indicate the valve position as open.

## Slam Shut-Off Valves

■ **Table 2: SERIES SH4 Model Configurations**

	SH4 /	0	2	-	025	-	30	/	0	E
<b>Function:</b>										
SH4/O	.... Over Pr. Shut Off									
SH4/P	.... Over & Under Pressure									
SH4/Q	.... With Remote Signal Devices (switches)									
<b>Set Pressure Range:</b>										
OPSO										
O1	.... 1.0 to 5.0 BarG	... NP5 (A)								
O2	.... 5.0 to 10.0 BarG	... NP5 (A)								
O3	.... 6.0 to 15.0 BarG	... NP5 (B)								
O4	.... 10.0 to 25.0 BarG	... NP5 (B)								
O5	.... 24.0 to 55.0 BarG	... NP3								
OPSO                      UPSO										
P0	.... 1.0 to 5.0 BarG	0.5 BarG to 2.0 BarG	.... NP6							
P1	.... 1.0 to 5.0 BarG	1.5 BarG to 6.0 BarG	.... NP6							
P2	.... 6.0 to 10.0 BarG	0.5 BarG to 2.0 BarG	.... NP6							
P3	.... 6.0 to 10.0 BarG	1.5 BarG to 6.0 BarG	.... NP6							
P4	.... 6.0 to 15.0 BarG	4.0 BarG to 10.0 BarG	.... NP6							
P5	.... 10.0 to 25.0 BarG	4.0 BarG to 10.0 BarG	.... NP6							
P6	.... 0.5 to 5.0 BarG	0.2 BarG to 1.0 BarG	.... NP6							
9	.... Higher / Lower set Pr. ranges									
<b>Valve size:</b>										
	025	.... DN 25								
	040	.... DN 40								
	050	.... DN 50								
	080	.... DN 80								
	100	.... DN 100								
	150	.... DN 150								
<b>Flange Rating</b>										
10	.... ANSI B16.5 150# (Max. differential Pressure 19 Bar) / PN 10/16/20									
20	.... ANSI B16.5 300# (Max. differential Pressure 48 Bar) / PN 25/40/50									
30	.... ANSI B16.5 600# (Max. differential Pressure 97 Bar) / PN 110									
<b>Other Special Features (if applicable) to be specified</b>										
E	.... Enhanced Cg Value									
R	.... Regular Cg Value									

# Slam Shut-Off Valves

## SPECIFICATIONS

**Body Size & Connections:**

**Flanged:** 1", 2", 3", 4" & 6" ANSI B16.5  
Class 150#, 300# & 600# (Higher sizes & ratings on request)

**Available Configurations:** As per Table-2

**Accuracy Group AG:** upto 1.0 (according to EN 14382)

**Response Time:** Less than 2sec

**Allowable Line Pressure:**

ANSI 150#: 20 Barg max. ANSI 300#: 50 Barg max. ANSI 600#: 98 Barg max.

**Flow Coefficients:** As per Table 1.

**Set Pressure Ranges:** As per Table 2

**Maximum Flow Capacities:** Can be derived referring the capacity calculations

**Material of Construction:**

**Body\*:** A216 Gr. WCB (Standard 150#), A352 Gr. LCB (Standard 300# & 600#), A351 CF8, A351 CF8M

**Internal Trim Parts\*:** SS316 (Standard), SS304, SS316L, SS304L, Copper, Brass

\*NACE & other special material available on request

**Disc & Diaphragm:** Nitrile (Standard), Neoprene, EPDM, Silicone, PTFE, Fluoropolymer

**Temperature Capabilities:** -20°C to 60°C

(extended temperature ranges available on request)

**Pressure Setting Adjustment:** May be adjusted throughout a spring range by turning the adjusting screw of pilot

**Pressure Registration:** External from downstream control line

**External Dimensions & Weights:** Refer Table 3

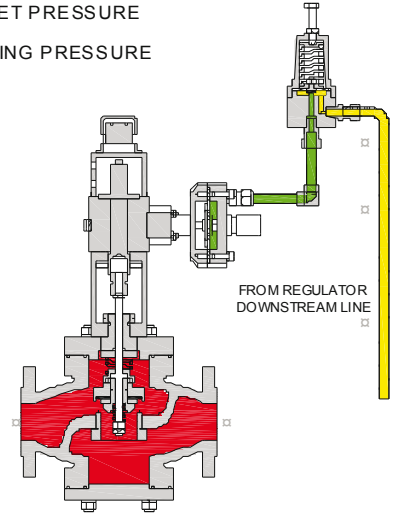
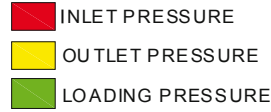

A

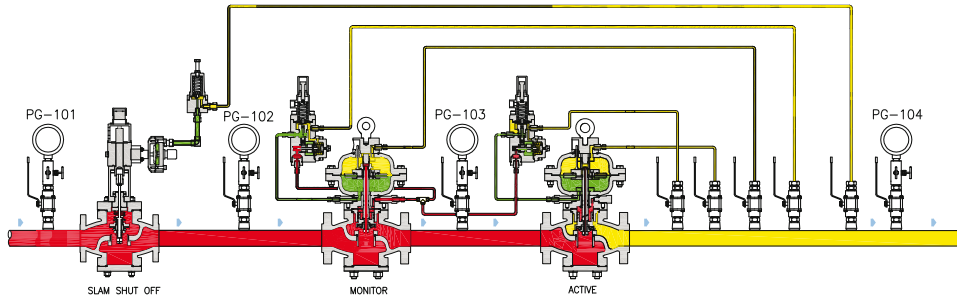

## Table 3: Dimensions & weights

ANSI 150#								
SIZE	H (MAX)	B	ØD	L	p	d	n	Weight
1" (25NB)	600	95	108	184	79.4	16	4	34
2" (50NB)	650	130	152.2	254	120.6	19	4	40
3" (80NB)	725	160	190.4	298	152.4	19	4	55
4" (100NB)	800	192	228.6	352	190.5	19	8	72
6" (150NB)	875	235	279.4	451	241.3	22.2	8	115

ANSI 300#								
SIZE	H (MAX)	B	ØD	L	p	d	n	Weight
1" (25NB)	600	95	123.6	197	89	19	4	38
2" (50NB)	650	130	165	267	127	19	8	48
3" (80NB)	725	160	209.5	317	168.3	22.2	8	65
4" (100NB)	800	192	254	368	200.1	22.2	8	85
6" (150NB)	875	235	317.5	473	269.7	22.2	12	130

ANSI 600#								
SIZE	H (MAX)	B	ØD	L	p	d	n	Weight
1" (25NB)	600	95	124	210	88.9	19	4	47
2" (50NB)	650	130	165	286	127	19	8	60
3" (80NB)	725	160	209.5	337	168.1	22.2	8	78
4" (100NB)	800	192	273	394	215.9	25	8	100
6" (150NB)	875	235	355.6	508	292.1	28.5	12	145

All dimensions are in mm & Weight in Kg      n = Number of Holes

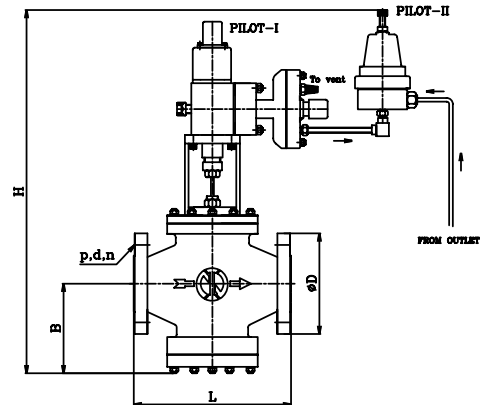



# Direct Acting Regulators

## Direct Acting Regulators



### D81 Series - Gas Pressure Regulator

The D81, High performance, High pressure lever type regulator is a direct acting (self actuated spring loaded) regulator, which can be used for all non-aggressive gases. This construction feature i.e. the lever mechanism ensures exact outlet pressure and provides quick response when the flow rate varies. Typical application includes residential, commercial, industrial applications and also as by-pass regulators for pressure reducing station, first-cut regulator ideal for use in multistage pressure reduction.

Figure 1: SERIES D81 PRESSURE REGULATOR

#### FEATURES

- **Glandless Construction:** Where positive zero gland leakage is required, the design scores over conventional Solutions such as BELLOW seal etc, as the gland itself is eliminated and hence there can't be gland leakage. Glandless construction eliminates hysteresis, resulting in improving the sensitivity and repeatability of the valve.
- **Tamper Resistant:** An adjusting screw with protective cap is standard to discourage tampering with pressure setting.
- **Orientation in 360° Direction:** Regulator can be mounted in any direction and can be easily repositioned while in-line.
- **Easy Maintenance:** Regulator internals can be inspected without removing body from line.
- **Tight Shut Off Capability:** Provides excellent tight shut off capability over long working life.
- **Pressure Sensing:** Externally sensing or external control line required to measure outlet pressure in downstream pipe work.
- **Over/Under Pressure Cut Off:** Available with integral over/under pressure Cut-off Slam shut valve.

#### SPECIFICATIONS

<b>Body Size &amp; Connection</b>	Valve size: NPS 1" (DN 25) (Other sizes available on request)		
	End connection styles: Flanged, Screwed (NPT/BSPT) & Socket weld end.		
	Flange Rating: ANSI Class 150#, 300# & 600#		
<b>Inlet Pressure</b>	Upto 100 Barg. (Higher available on request)		
<b>Port Size</b>	Refer Table 3		
<b>Material of Construction</b>	<b>Body*:</b> A216 Gr. WCB (Standard), A351 Gr. CF8, A351 Gr. CF8M		
	<b>Diaphragm Casing &amp; Spring Housing*:</b> A216 Gr. WCB (Standard), A351 Gr. CF8, A351 Gr. CF8M		
	<b>Internal Trim Parts*:</b> SS 316 (Standard)		
	*(NACE & other special material available on request)		
<b>Temperature Capabilities</b>	<b>Disc &amp; Diaphragm:</b> Nitrile (Standard), Neoprene, EPDM, Silicon, PTFE, Fluoropolymer		
<b>Pressure Setting Adjustment</b>	May be adjusted throughout a spring range by turning the adjusting screw	<b>Pressure Registration</b>	Internal as well as External
<b>External Dimensions</b>	Refer Table 7 & 8		

Table 1: D81 SERIES SPRING RANGES FOR REGULATOR

Outlet Set Ranges		Spring colour code
Psig	Barg	
5 - 20	0.3 - 1.4	Yellow
15 - 20	1.0 - 2.8	Green
35 - 80	2.4 - 5.5	Red
70 - 150	4.8 - 10.3	Dark Blue
138 - 246	9.5 - 17.0	Red
232 - 493	16.0 - 34.0	Dark Blue



## Direct Acting Regulators

### PRODUCT DESCRIPTION

The D81 regulator is a direct operated pressure reducing regulator for low and high pressure systems. These regulators can be used with natural gas, air or variety of other gases. The required outlet pressure Natural Gas can be easily set to another set pressure range by adjusting the set screw or by exchanging the spring, due to its spring principle this type of regulator operates independently of its position. Referring to figure 2, when the downstream demand increases, pressure under the diaphragm decreases. Spring force pushes the diaphragm assembly downward direction and the valve disc moves away from the orifice allowing more flow through the body to the downstream system. Similarly when the downstream demand decreases, the pressure under the diaphragm increases. This pressure overcomes the regulator setting (which is set by spring). Through the action of the diaphragm assembly, lever and valve stem, the valve disc moves closer to the orifice and reduces gas flow.

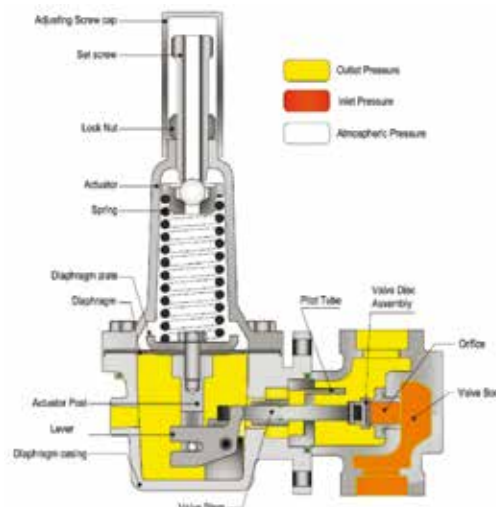

Figure 2: TYPICAL MODEL REGULATOR D81-I

### Gases & Vapors:

Natural gas regulating capacities for inlet pressure and outlet pressure settings are given in Tables 5 and to determine wide-open flow capacities use the following formula i.e. Universal Gas Sizing equation;

$$Q = \frac{7.55}{C_g \times T} \times C_g \times P_1 \times \sin \left\{ \frac{3417}{C_1} \times \sqrt{\frac{P_1 - P_2}{P_1}} \right\} \text{ Degrees}$$

**Note:** To obtain the published capacities, the inlet and outlet piping should be designed, such that the velocity in the pipeline is less than 30 m/sec.

Where;

- Q = flow rate (SCMH)
- C<sub>g</sub> = Gas sizing co-efficient (Refer Table 3)
- P<sub>1</sub> = Inlet pressure (bar(a.))
- P<sub>2</sub> = outlet pressure (bar(a.))
- T = Temperature in °Kelvin (T = 273+°C)
- G = Specific gravity (0.6 for Natural gas)
- C<sub>1</sub> = Valve recovery co-efficient (C<sub>1</sub>=C<sub>g</sub>/C<sub>v</sub>)(Refer Table 3)
- C<sub>v</sub> = Liquid sizing coefficient

### Table 2: D81 SERIES MODELS

Model Name	Model Number
PRV with Internal Sensing	D81-IR
PRV with External Sensing	D81-ER
PRV with Internal Sensing & High Pressure Arrangement	D81-IH
PRV with External Sensing & High Pressure arrangement	D81-EH
PRV with Internal Sensing & Slam Shut Valve	D81-IS
PRV with External Sensing & Slam Shut Valve	D81-ES
PRV with Internal Sensing & Creep Relief Valve	D81-RA
PRV with internal sensing, Creep relief valve & slam shut off valve	D81-RS

### Table 3: FLOW CO-EFFICIENTS

Orifice	1/8" (3.2)	1/4" (6.4)	3/8" (9.5)	1/2" (12.7)	3/4" (20)
C <sub>g</sub>	12	47	108	170	335
C <sub>1</sub>	32	32	34	38	38

# Direct Acting Regulators

## SERIES D81 MODEL CONFIGURATIONS

**D81 - ES - 12 - K - 21 - 1215 -**

### Valve Constn

IR	Internal Sensing (Regular)
ER	External Sensing (Regular)
IH	Internal Sensing with High Pressure arrangement
EH	External Sensing with High Pressure arrangement
IS	Internal Sensing with Slam Shut Valve
ES	External Sensing with Slam Shut Valve
RA	Internal Sensing with Creep Relief Valve
RS	Internal Sensing with Creep Relief Valve & Slam shut off valve

### Valve Size

1	DN 25 (1")
2	Others

### Orifice Size in mm

1	3.2
2	6.4
3	9.5
4	12.7
5	20 (External Sensing)
6	Others

### Set Pressure Ranges

J	0.3 - 1.4 Barg
K	1.0 - 2.8 Barg
L	2.4 - 5.5 Barg
M	4.8 - 10.3 Barg
N	9.5 - 17.0 Barg
O	16.0 - 34.0 Barg

### End Connection & Rating

11	Screwed to NPTF
12	Screwed to BSPF
21	Flanged RF ANSI B16.5 150# (max. 19 Bar)
22	Flanged RF ANSI B16.5 300# (max. 48 Bar)
23	Flanged RF ANSI B16.5 600# (max. 98 Bar)
99	Others (to be specified)

### Material of Construction

Body	Internal Trim*	Diaphragm	Soft Seat**
1	A216 WCB 1 SS316	1 Nitrile	1 Nitrile
2	A351 CF8 2 SS316 + AL	2 Neoprene	2 Neoprene
3	A351 CF8M 0 Others	3 EPDM	3 EPDM
4	A351 CF3	4 Viton	4 Viton
5	A351 CF3M	0 Others	5 Teflon
0	Others		

### Other Optional Features (on demand)

NE	NACE
RT	Body Casting Radiography

\* Note (1): Trim SS316 + AL is available with Set Pressure Range of 0.3 to 1.4 Barg (5 to 20 Psig) only

\*\* Note (2): Teflon seat shall be provided when the inlet pressure is above 50 Barg

## Direct Acting Regulators

### SERIES D81 Pressure Regulator with Slam Shut Off Valve & Creep Relief Valve

Series D81-S, Pressure Regulator offers the possibility of installing a Slam Shut valve as shown below in the Figure 3. This device immediately stops gas flow whenever a failure causes downstream pressure to rise reaching the set point of the slam shut valve.

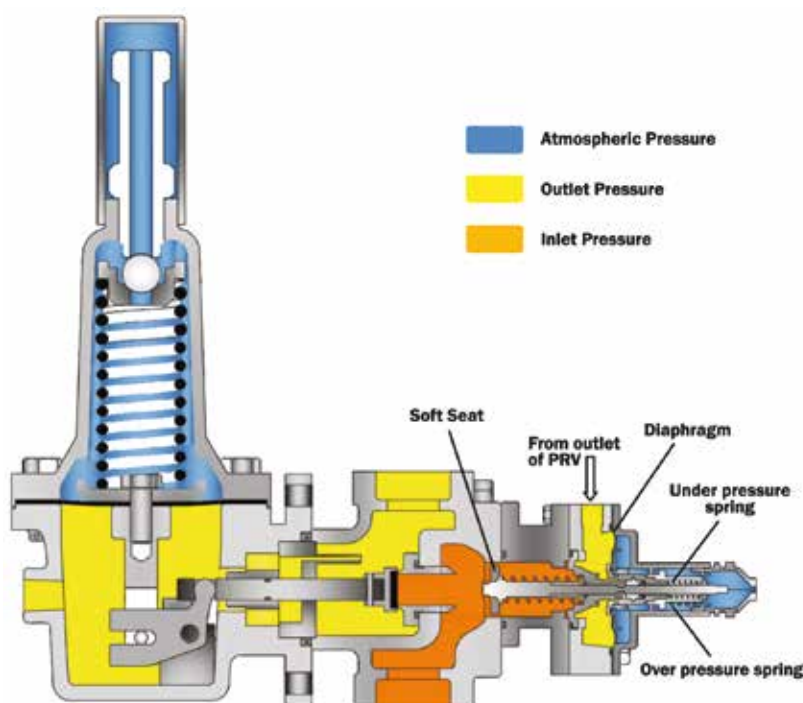

FIGURE 3: TYPICAL D81-S MODEL PRESSURE REGULATOR WITH SLAM SHUT VALVE

### FEATURES

- The SSV is designed to monitor the outlet pressure and to interrupt the gasflow, if preset limits are exceeded
- This preset pressure is adjustable in the field
- If the measured pressure reaches the set point of the SSV, a release mechanism is triggered and the SSV closes the valve on the inlet pressure side of the regulator
- Safety slam shut valves are available in over pressure cut off (OPCO) protection or Under and Over pressure cut off (UPCO/OPCO) protection
- After the SSV is tripped, the condition that triggered the closing of the valve must be addressed and then the SSV can be manually reset
- As an optional integral creep relief valve shall be provided

### Table 4: D81 SERIES SPRING RANGES FOR SLAM SHUT VALVE (SSV) & Creep Relief Valve (CRV)

FOR OVER PRESSURE SHUT-OFF (OPSO)			FOR UNDER PRESSURE SHUT-OFF (UPSO)		
Spring Range	Coil Dia.	Color	Spring Range	Coil Dia.	Color
1.0-2.5 bar	Ø2.5	Yellow	0.6 - 1.3 bar	Ø1.5	Red
2.3-4.0 bar	Ø3.0	Green	1.0 - 2.0 bar	Ø1.6	Blue

Note (1): Regulator with Slam Shut Valve shall be provided for the maximum inlet pressure up to 10 barg.

Note (2): Regulator with Slam Shut Valve is available with port size 3.2, 6.4, 9.5, 12.7 & 20 mm

Note (3): As an optional available spring range for creep relief valve is 0.5 to 1.5 bar, 1.0 to 2.5 bar, 2.3 to 4.0 bar.

Note (4): For higher spring ranges, please consult our sales team.

Note (5): External Sensing for 20mm port.

Note (6): Upto 10 Barg set pressure available with 20 mm port.

# Direct Acting Regulators

## SERIES D81 - DIMENSIONS

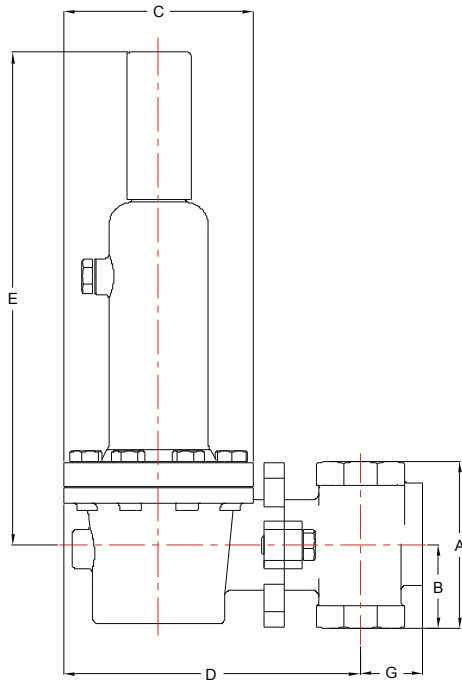

**Figure 3: NPT DIMENSIONS**

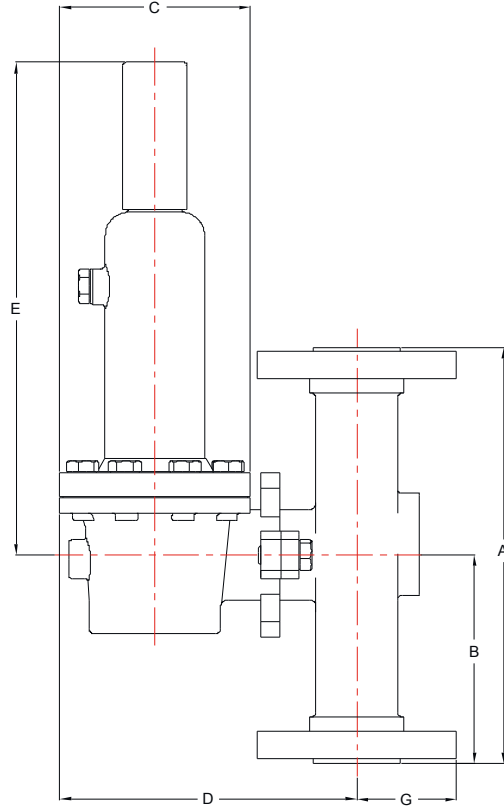

**Figure 4: FLANGED DIMENSIONS**

### TABLE 7: DIMENSIONS FOR SCREWED & SOCKET TYPE END CONNECTIONS (REFER FIG. 3)

BODY SIZE NPS	A	B	C	D	E	G
1"	108.0	54.0	120.0	190.0	325.0	40.0

### TABLE 8: DIMENSIONS FOR FLANGED TYPE END CONNECTIONS (REFER FIG. 4)

BODY SIZE NPS	Rating	A	B	C	D	E	G
1"	150#	184	92	120	190	325	54
	300#	197	98.5	120	190	325	61.5
	600#	210	105	120	190	325	61.5

# Global Standard of Excellence

## QUALITY ASSURANCE

The Quality Assurance system of Nirmal ensures that innovative solutions are delivered through processes which are assessed, approved & certified to ISO 9001:2008 Quality Assurance standard. Strict adherence to procedures by disciplined and dedicated work force and internal audits, guarantee that the quality system is implemented across all stages, from incoming raw materials to final test and delivery. One of the most prestigious accolades earned is the U & R Stamp Certification which authorizes the use of the symbol of American Society of Mechanical Engineers (ASME). It assures customers that the stamped products are built in accordance with the applicable rules of the ASME Boiler and Pressure Vessel Code. Nirmal is the first Indian manufacturer to get its products certified with stringent European Standards EN-334 & EN-14382 for Pressure Regulators and Safety Shut Off Valves ensuring world-class product performance & accuracy.



ISO 9001:2008

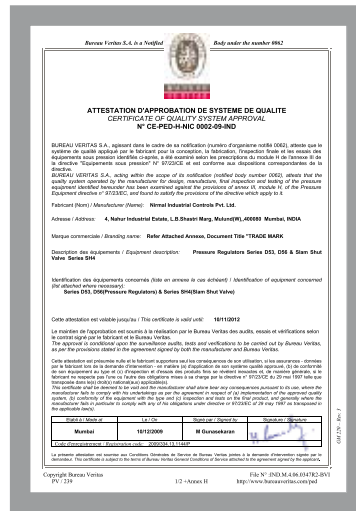

PED/97/23/EC (CE) Compliance Certificate

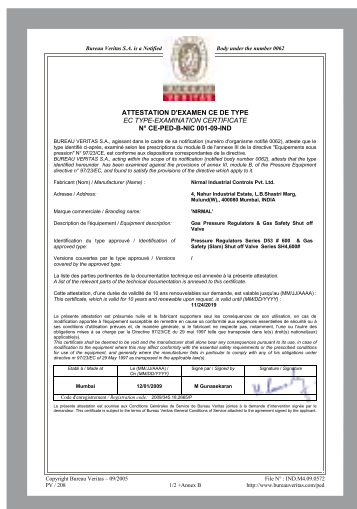

Type Test Certificate to EN-334 & 14382



ASME U & R Stamp Certificate

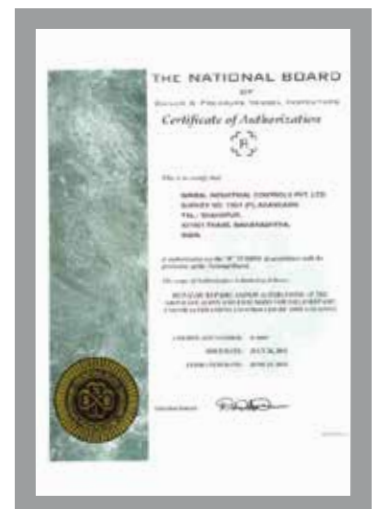





**CAVAGNA group**

Wherever gas is used, we are there

# Manufacturing Facilities



